

INSTRUCTIONS FOR CONTROLLER

GH21TA

FOR CENTRAL HEATING BOILER CONTROLLER WITH PISTON FEEDER

USER MANUAL

We strongly recommend that you familiarise yourself fully with the contents of this manual before installing and using any of our devices. If you have any questions, please contact us between 08:00 and 16:00

Table of contents

1.	DESCRIPTION OF CONTROLLER.....	3
2.	TECHNICAL SPECIFICATIONS.....	3
3.	REQUIREMENTS FOR ELECTRICAL INSTALLATION.....	4
5.	CONTROLLER MODES.....	6
5.1.	STANDBY MODE	7
5.2.	AUTOMATIC MODE - HEATING.....	7
5.3.	AUTOMATIC MODE - MAINTAIN.....	8
5.4.	MANUAL MODE.....	8
5.5.	ALARM/NOTE MODE.....	9
5.6.	EMERGENCY WORK.....	9
6.	OPERATING THE CONTROLLER.....	9
6.1.	CONTROLLER FASCIA PANEL	9
6.2.	OPERATING THE CONTROLLER – MAIN SCREEN	11
6.3.	PREVIEW OF SYSTEM OPERATIONS.....	11
6.4.	HELP BUTTON.....	12
6.5.	MANUAL MODE.....	13
6.6.	CONTROLLER MENU – GRAPHIC TREE.....	14
7.	DESCRIPTION OF ADDITIONAL FUNCTIONS.....	20
7.1.	DHW PRIORITY (HOT WATER)	20
7.2.	SUMMER FUNCTION.....	20
7.3.	ANTI-LEGIONELLA FUNCTION.....	20
7.4.	GA03HA ROOM PANEL.....	21
7.5.	FUEL FEEDER TEMPERATURE DETECTION.....	22
7.6.	BOILER EXTINGUISHED DETECTION.....	23
7.7.	ANTI-STOP FUNCTION.....	23
7.8.	GRATE MODE.....	24
7.9.	PUMP ONLY MODE.....	24
7.10.	OPERATION RECORD	24
7.11.	EMERGENCY WORK	24
8.	SYSTEM INSTALLATION.....	25
8.1	HEATING INSTALLATION NUMBER 1.....	25
8.2	HEATING INSTALLATION NUMBER 2.....	26
8.3	HEATING INSTALLATION NUMBER 3.....	27
9.	CONTROLLER ALGORITHMS FOR ATTACHED DEVICES.....	28
9.1	HEATING MODE – FUEL FEEDER	28
9.2	AUTOMATIC MODE – CH PUMPS	28
9.3	HEATING MODE - FAN	28
9.4	AUTOMATIC MODE – DHW/MIXER PUMP.....	29
9.5	MAINTAIN MODE – FAN AND FEEDER.....	29
10.	ALARMS	30
11.	EMERGENCY WORK.....	36
12.	TEMPERATURE LIMITER (STB).....	37
13.	LOSS OF POWER.....	38
14.	GH03HA ROOM PANEL	39
15.	IN CASE OF DAMAGE TO THE CONTROLLER.....	40
16.	INFORMATION REGARDING THE LABELING AND DISPOSAL OF WASTE ELECTRONIC AND ELECTRICAL EQUIPMENT	43

1. Description of controller

The GH21TA controller is assembled using microprocessor techniques utilising automatic surface mounting.

This controller is a device used to control the process of preparing domestic hot water (the DHW circuit), and provides support for the main circuit (circuit CH). Parameters can be adapted according to the condition and the type of boiler.

The controller is equipped with a system to guard against power failure and various types of interference. The controller identifies each emergency and gives a visual and audio warning.

The controller automatically supports three installation configurations, which meet the requirements of the installer fully. The device supports three temperature sensor inputs, digital input for reed relay switch, additional output for room panel GA03HA, and four outputs for external devices.

The GH21TA controller is equipped with:

- Temperature inputs:
 - to measure the temperature of the water coming from the boiler
 - to measure the temperature of the feeder tray
 - to measure the temperature of the water in the boiler / returning CH temperature
- Digital input
 - for connecting cotter pin break sensor to boiler piston feeder – reed relay
- Input (RS485)
 - Dedicated connector for GECO GA03HA room panel

2. Technical specifications

Supply voltage	230V ~ +10% -15%
Operating temperature	od +5°C do +40°C
Humidity	od 20% do 80% RH
Fuse – Fan, Feeder	3.15A
Sensor type	NTC 2.2kΩ
Sensor temperature operating range	NTC: 0°C÷100°C

Input	Maximum continuous load	
CWU pump	1A	250W
CO pump	1A	250W
Fan*	1A	250W
Feeder*	1A	250W

Resistance characteristics of NTC sensor	
Temp. °C	Resistance Ω
0	7174.89
10	4374.83
20	2747.10
30	1774.91
40	1172.09
50	795.08
60	547.95
70	384.62
80	275.86
90	202.37
100	149.16



****When a contactor or relay proxy is connected, use a dedicated blowout system (eg varistor). Omission of this security measure may result in malfunction or damage to the controller output.***

3. Requirements for electrical installation

WARNING!

Only a person with a valid licence to carry out electrical installation work can install the controller wiring and connection technologies. It is recommended that the work is carried out by a qualified installation engineer. The following are the basic requirements for the electrical power supply for this particular controller:

1. Repairs, maintenance and other work on the system can be carried out only after disconnecting the main power supply.
2. The room in which the controller is to be installed should be equipped with 230V/50Hz electrical system in accordance with the applicable regulations.
3. The controller should be supplied from a dedicated circuit 230VAC/50Hz grid, protected by a circuit breaker.
4. The controller power cable should have a cross section minimum mechanical strength of 2.5 [mm²]
5. The cable must be protected from mechanical damage, by keeping it in a duct or housing

4. Graphic and text descriptions of driver connections

When the cable has been prepared, you will be ready to connect the power to the controller and temperature sensors, thermostats and other devices:

- The 230 V power supply should be connected to the controller using the terminals marked "L" and "N" – in inputs 01-02.
- The NTC temperature sensor must be connected to the inputs in accordance with the instructions set out in the tables in section 8, System Installation. Please note that the number of sensors supported depends on the type of installation, and unused sensors do not have to be connected to inputs.
- The room panel GA03HA must be connected to a separate input, as described.
- Technological equipment (pumps / fans / feeder) should be connected to the outputs, as described in the tables in section 8, System Installation and according to the selected installation

Input parameters are described in the following tables:

Description of controller inputs – temperature sensors		
Temperature sensor	Type of input	Controller designation
Water flowing from the boiler	NTC	50-51
Water in the DHW boiler/ Return temp.	NTC	52-53
Fuel feeder	NTC	54-55
Description of controller inputs – room thermostat GA03HA		
Type of room thermostat	Type of input	Controller designation
GH21TA dedicated room panel - GECO	RS485	58-59-60-61
Description of controller inputs – digital		
Cotter pin break sensor for feeder	Type of input	Controller designation
Reed relay	CTC100	56-57

Description of controller outputs – technological equipment		
Device installed	Type of input	Controller designation
CH pump	Relay	05-06
DHW pump	Relay	07-08
Feeder	TRIAC	09-11
Fan	TRIAC	12-14

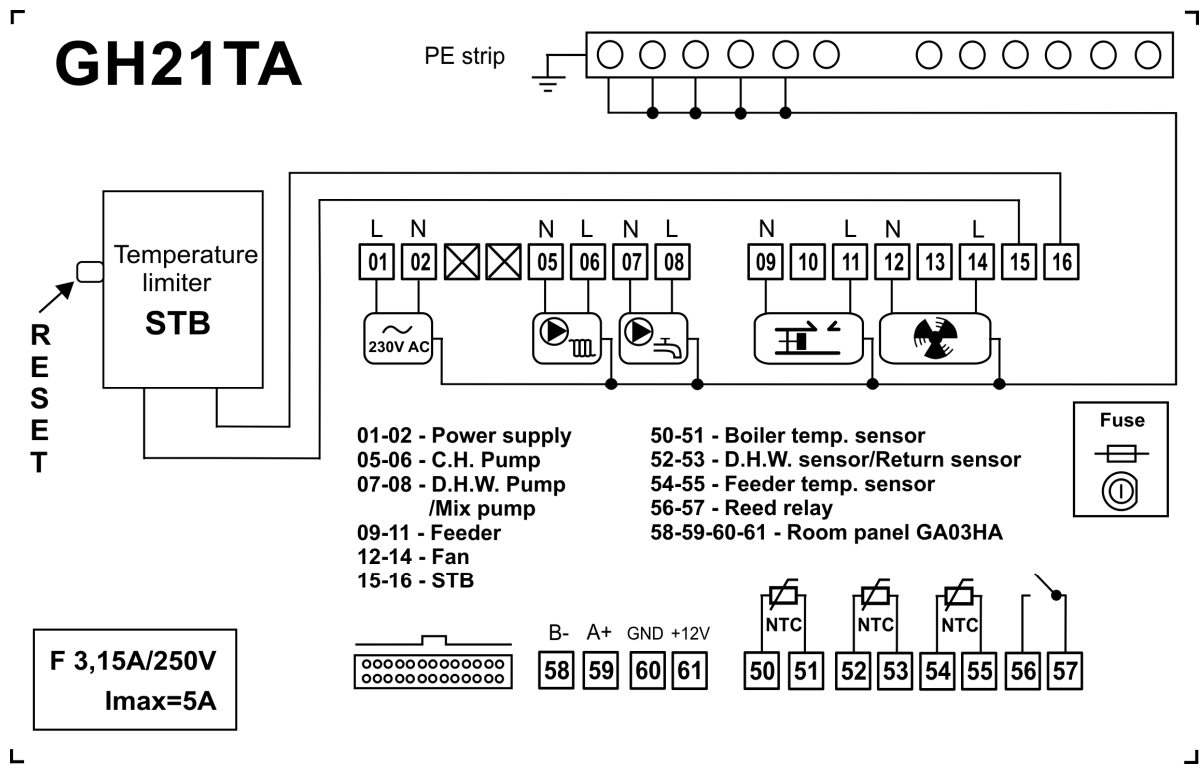

ONLY A QUALIFIED WIRING TECHNICIAN MAY CONNECT DEVICES TO THE GH21TA CONTROLLER.

5. Controller modes

The controller can be operated in five modes:



- **Standby** – returns the controller to the state before loss of power. The controller algorithm is not implemented, the clock operates in real time, and the chosen installation settings are stored.
- **Automatic** - There are two sub-modes, heating and maintain
Heating – in this mode, the algorithm is implemented in the control mode selected depending on the type of fuel
Maintain - the controller enters this mode if the boiler temperature reaches the set point. In this mode, an individually prepared algorithm is implemented.
- **Manual** – This mode is used only to validate the on / off (tests) for each installation of technological equipment, so when you are sure that tests are finished, go to the automatic mode.
- **Alarm** – Characterised by the occurrence of an alarm that prevents further operation of the equipment or the occurrence of a warning, which allows the user to accept temporary operation under warning conditions accepted by the user with the awareness that it is temporary in nature. When the fault is resolved, the driver returns to the mode it was in before.

- **Emergency work** – Emergency work allows the boiler to work in case of damage to the feeder and or fan TRIAC, until servicing is possible.

5.1. Standby mode

After the installation procedure described in the previous chapter, the GH21TA driver is turned on standby. In this mode, the screen displays a message about how to select automatic or manual mode.



When the controller is in standby mode, you can switch to manual mode using the button . During normal operation, it is possible to return the controller to standby mode at any time, by pressing the button .

In standby mode, all outputs and the alarm sound signal are disabled. When the controller is switched to automatic mode, the display shows the actual temperature of the water in the boiler, the set temperature, and information about the controller mode.

5.2. Automatic mode - heating

In automatic mode, the controller implements the control algorithm for the chosen heating schema, according to the heating regulation option chosen. Basic information about the system, displayed on the main screen, includes current and set boiler temperature, and operating mode. The user may choose from three heating regulation options: Standard, grate mode and pump only.

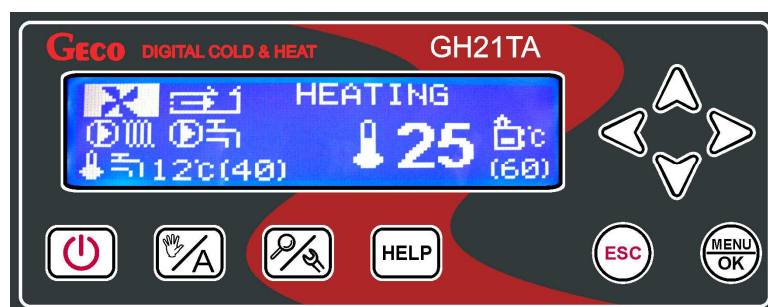

In automatic heating mode, the controller displays text information in the top part of the screen:

Heating – when the standard regulation option is set

Grate mode H – when the grate mode option is set

Pump only – when the pump only mode is set

A detailed description of non-standard heating regulation options can be found in section 7.

5.3. Automatic mode - maintain

The controller enters this mode if the temperature in the boiler reaches that set by the user in the parameters menu.

The fuel feeder and fan are disabled, for the time set by the user in the ‘maintain time’ parameter. After this time, the controller turns on the feeder and fan for the time set by the manufacturer (service parameter S20). It is usual for the fan to operate longer than the feeder during the time set in service parameter S18, in order to ignite the fuel supplied.

The controller will exit maintain mode and return to automatic mode, if the temperature of the boiler falls below the value set in installation parameter ‘boiler temperature hysteresis’, which can be edited by the user. The central heating pump works in the same way as in automatic mode.

When working in automatic mode maintain, text information is shown in the top part of the screen:

Maintain – when the standard option is set

Grate mode M– when grate mode is set

A detailed description of non-standard heating regulation options can be found in section 7.

5.4. Manual mode

In manual mode, the controller does not implement the control algorithm, and the number and type of technological devices connected is dependent on the user, who takes responsibility for the correct operation of the equipment. On the main screen, the actual and set boiler temperature is always displayed. The choice of heating regulation option does not affect the operation of the system in manual mode. In this case, the user has full control over what equipment will be operated by the controller.

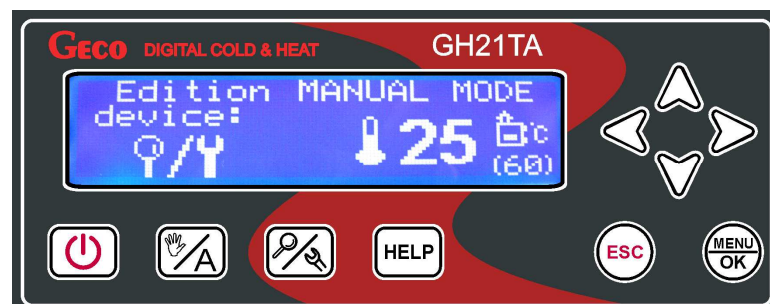

After entering the manual mode, operation of all equipment will be stopped automatically. The controller working in automatic mode displays text information at the top of the screen – ‘manual mode’.

5.5. Alarm/Note mode

Alarm - The controller goes into alarm mode when one of the required sensors fails or is disconnected, or when the cable is broken. The controller will signal that the sensor in question is required. When the fault is repaired, the controller returns to the mode it was in before. The controller will not enter alarm mode when the sensor fault has been repaired. Any changes to components should be done with the controller turned off.

Note - The controller switches to warning mode when the DHW/returning sensor fails or is disconnected, or when the cable is broken. The controller then gives information about the warning, and the types of operations conditionally possible without the sensor. The user must always accept operations that are conditional on the lack of sensor, each time the controller is restarted. This applies only to those sensors which do not affect the safe operation of the heating system. The other functions of the note mode are to give information when the hot water tank has not been disinfected, or the temperature in the feeder has not been raised. The controller exits the notes mode when one of the notes is UW10 or UW17.

5.6. Emergency work.









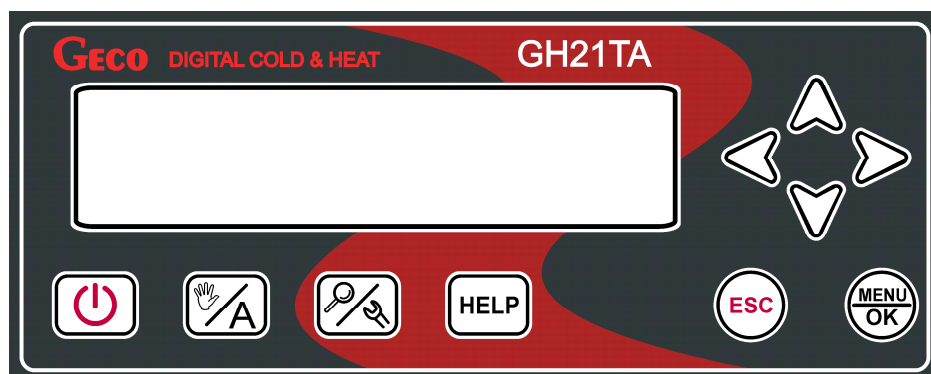

Safe mode allows the boiler to work in case of damage to the feeder and or fan TRIAC, until servicing is possible. For the controller to operate the feeder / fan in safe mode, the correct mode should be selected from the menu, in addition to changing the feeder/fan connection. A detailed description is on page 39.

6. Operating the controller

Operating the controller is described in this chapter. It includes turning it on, using the keyboard, a working preview of the measuring system, reading text or characters on the screen, and editing the parameters available to the user.

6.1. Controller fascia panel



Button	Description	Function
	Turn on/off	The main screen appears
	Change modes Switch between manual and automatic	In the 'boiler mode bar', Manual Mode appears, or in the case of Automatic Mode, the display reads Heating, Grate Mode H, Pump only, Maintain, or Grate mode M
	Automatic mode allows a view of devices, temperature and accompanying features. In manual mode, view temperature and accompanying features, and see devices which can be edited.	The screen shows temperature, devices and accompanying features
	From the main screen, go to the user help menu. From the alarm and note screen, go to Data service	The screen shows help for users. The screen shows product information and service helpline information.
	Confirm change. Enter Menu from the main screen	Saves change Goes to Menu from the main screen
	Exit without confirming changes. Hold the button for three seconds to go to the main screen	Exit to previous screen or higher level menu
	Right arrow Quickly go to boiler output temperature screen from the main screen.	Move to the next column or row on the right. The screen displays boiler output temperature.
	Left arrow Quickly go to boiler output temperature screen from the main screen.	Move to the next column or row on the left. The screen displays boiler output temperature.
	Up arrow Increase value	Go to the next position above Increase the value by one step
	Down arrow Decrease value	Go to the next position below Decrease the value by one step



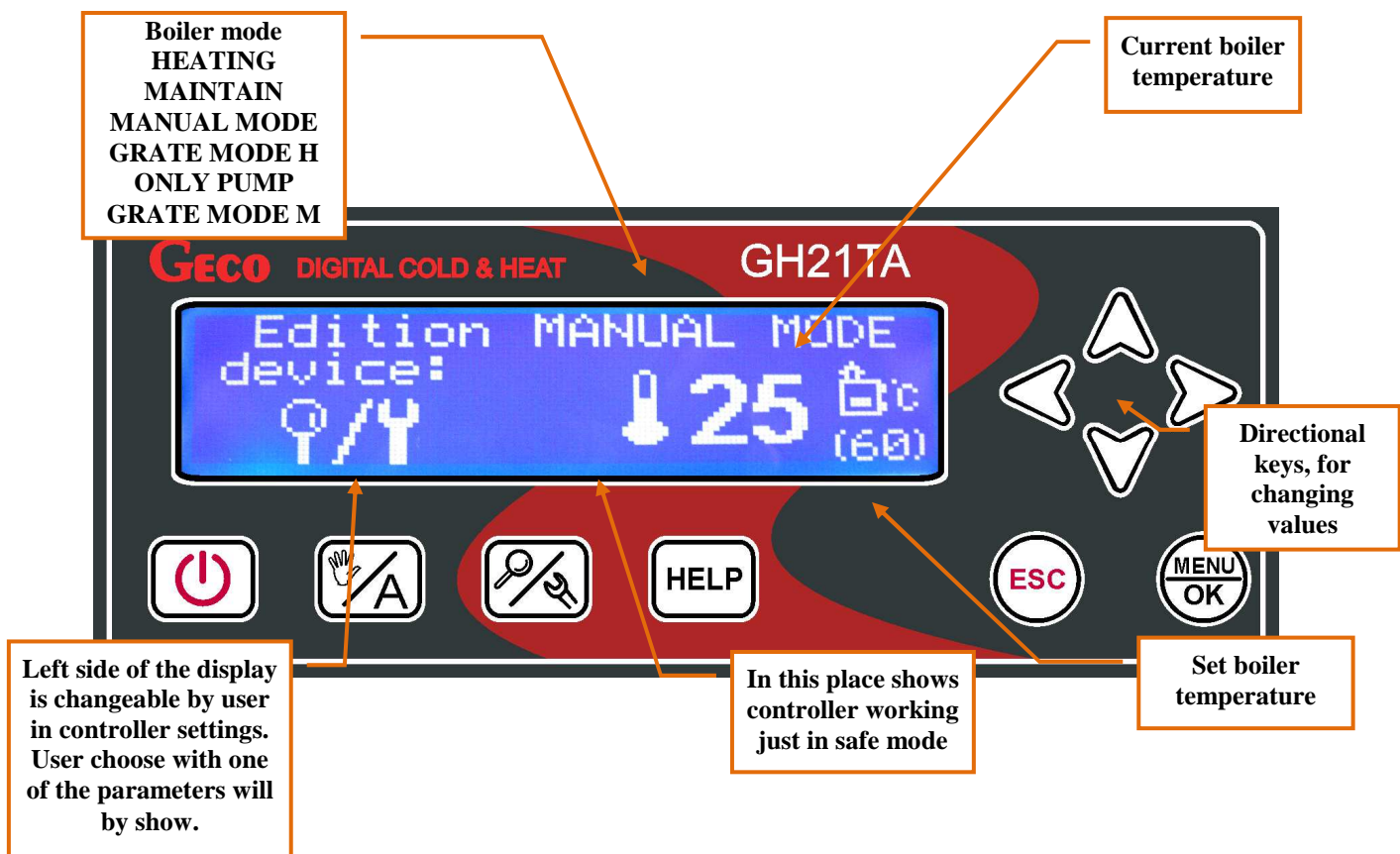
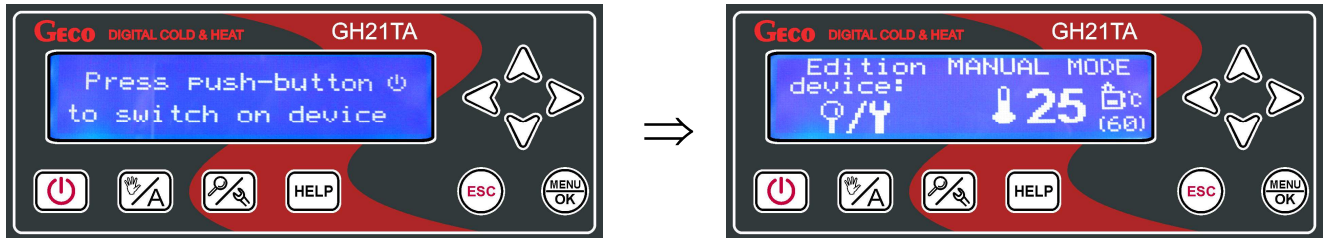

6.2. Operating the controller - main screen

When first connected to a power source, the controller turns on in standby mode. The function button  is used to turn the controller on/off, and to move from standby to manual mode.



6.3. Preview of system operations

The controller offers a quick preview of system operations. When you press the button  in any mode, you can preview all the major parameters of the controller, ie temperature measured by the controller, device status, and active / inactive control functions.

All information on the work of the heating system are divided into categories and placed on separate screens. Move between the screens by using the buttons  . At the bottom of every screen there is a text description of the item. Move between items on the screen using the buttons  .



The cursor shows the position on the screen. The current device is shown by the negation of the icon corresponding to the device. Current additional functions are shown in the same way. System temperature preview is possible in all controller modes. In the manual mode, it is also possible to switch devices on and off.

6.4. Help button

Using the button  from the main screen opens the help menu, from where the user can get service information and descriptions of all icons displayed on the controller's screens.

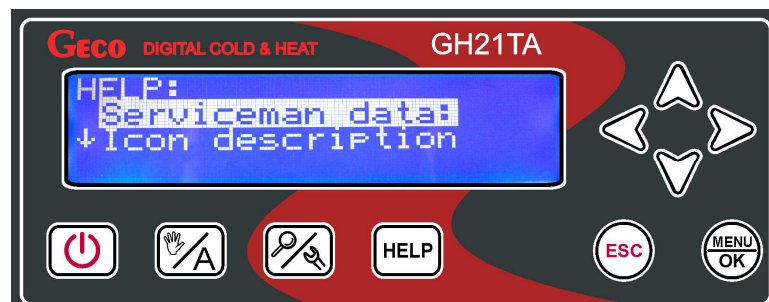

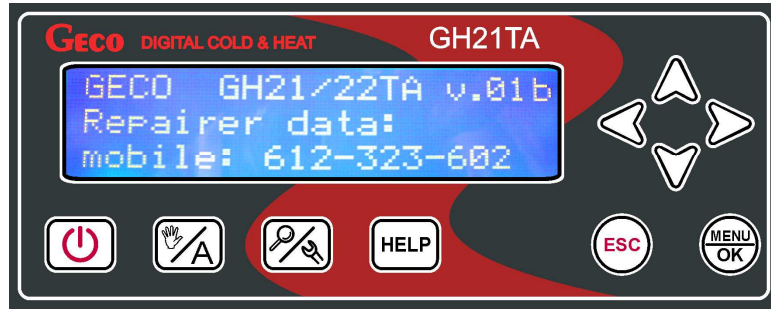

Basic information about the boiler and controller manufacturer is available:



USING THE BUTTON  FROM ALARM MODE TAKES YOU TO SERVICE INFORMATION. THE FOLLOWING IS DISPLAYED ON THE SCREEN: CONTROLLER MODEL, PROGRAMME NUMBER, AND TELEPHONE CONTACT DETAILS FOR THE MANUFACTURER OR TECHNICIAN.

6.5. Manual mode

Pressing the button  in automatic mode switches the controller to manual mode, and immediately stops all devices.

In this mode, the user can manually turn on/off the fan, feeder, heating pump and hot water pump, independently of each other. To do this, press the button  which will open the screen for editing the devices.



After moving to the desired position on the screen, according to the information text at the bottom, using the button  will switch on and off the selected device. The cursor shows the position on the screen. The device to be switched on or off is indicated by a backlit icon.

6.6. Controller menu - Graphic tree

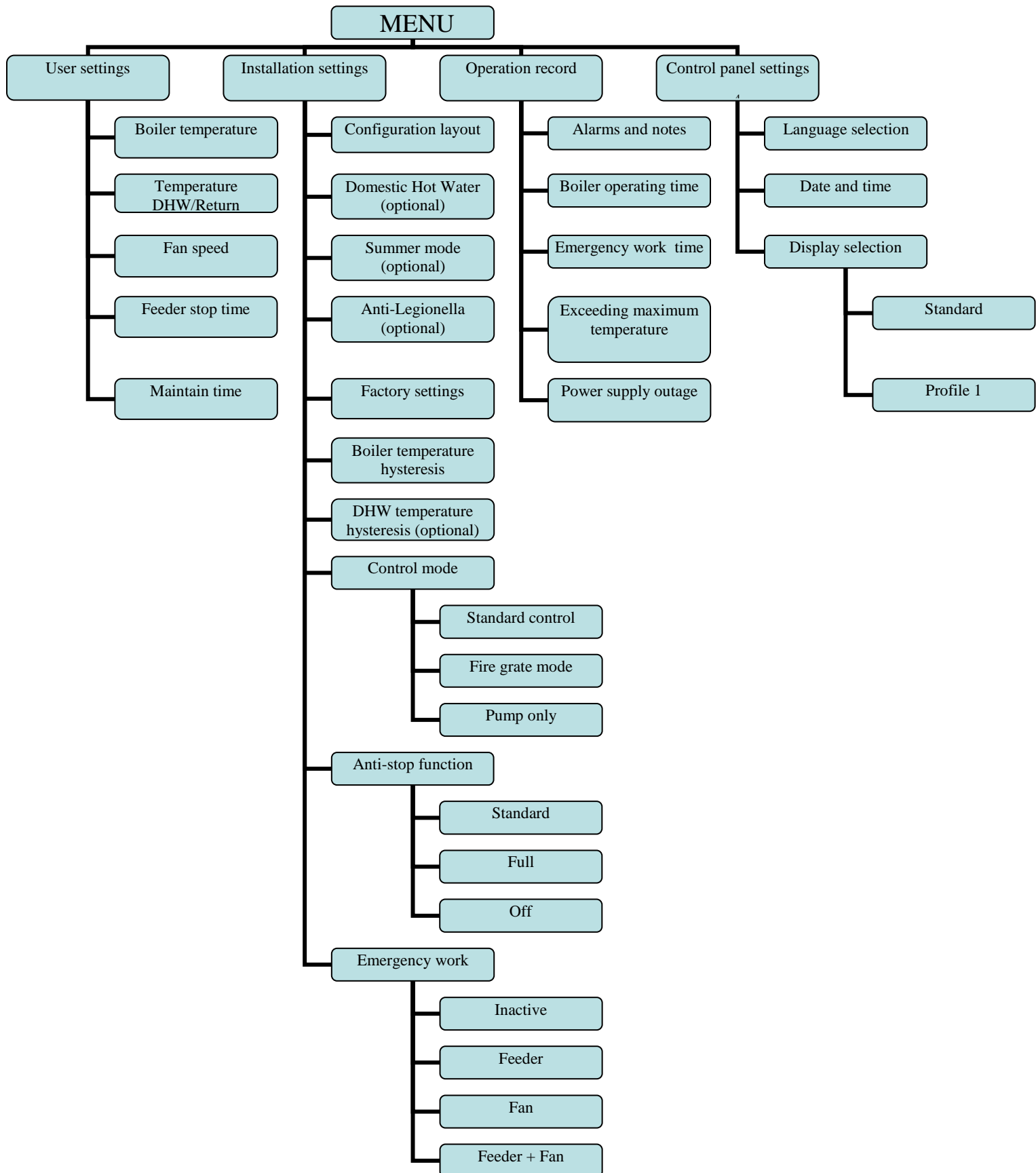

6.6.1 User settings

Description of user settings parameters	Min	Max	Factory settings
Set boiler temperature	'S3'	'S4'	50°C
Set DHW/returning temperature (optional)	35	65	40°C
Fan speed	1	10	5
Feeder stop time	5	250	45s
Maintain time	1	250	15min

- **Set boiler temperature** – Temperature that the boiler will reach
- **Set DHW/returning temperature** – Temperature to which the boiler will rise. This parameter is available for users only when the DHW (temp DHW)/additional mixer pump (temp returning) option is selected.
- **Fan speed** – This parameter sets the fan speed, i.e., the amount of air supplied. It allows the selection of fan speed depending on the quality and type of fuel used.
- **Feeder stop time** – This is the interval between each supply of fuel to the boiler in AUTO mode. The range varies from 5 s to 250 s.
- **Maintain time** – The time after which the controller switches on the fan and feeder, specified by the manufacturer to prevent the boiler shutting down in maintain mode. The range is from 5 min to 250 min.

6.6.2 Installation settings

Description of installation parameters	Min	Max	Factory settings
System configurations: (1) - K1: Boiler + CH (2) - K2: Boiler + CH + DHW (3) - K3: Boiler + CH + Mixer	1	3	1
DHW priority (optional)	No	Yes	No
Summer mode (optional)	No	Yes	No
Anti-Legionella (optional)	No	Yes	No
Boiler temperature hysteresis	2	10	5°C
Temperature hysteresis of DHW/returning (optional)	2	10	5°C
Regulation option: (1) - Standard (2) - Grate mode (3) - Pump only	1	3	1
Anti-stop function: (1) - Standard (2) - Complete (3) - Inactive	1	3	3
Emergency work: (1) - Inactive (2) - Feeder (3) - Fan (4) - Feeder + Fan	1	3	1

- **System configuration** – Allows selection of the heating system operated by the controller, with an additional pump or without. A description of the system is in section 8.
- **DHW priority** – Activating the function makes water heating the primary function of the Controller. A description of the functions in section 7.
- **Summer mode** – This function turns off the central heating pump and the boiler operates only to heat water. A description of this function is in section 7.
- **Anti-legionella** – This is aimed at limiting the growth of bacteria of the genus legionella pneumophila in the hot water. A description of this function is in section 7.
- **Boiler temperature hysteresis** – value of the boiler temperature hysteresis, at which maintain mode is exited and heat mode is resumed.
- **DHW temperature hysteresis** – value of DHW temperature hysteresis, at which the pump returns to hot water mode, or exits maintain mode.

- **Regulation option** – Allows customisation of the system operation algorithm according to type of fuel and technical capabilities. A description of this function is in section 7.
- **Anti-stop function** – Allows a security function for connected devices, which guards against system deterioration during the summer months. A description of this function is in section 7.
- **Emergency work** – Safe mode allows the boiler to work in case of damage to the feeder and or fan TRIAC, until servicing is possible. A description of this function is in section 7.

6.6.3 Operation history

Operation history is where information on all controller malfunctions and custom activities is stored. All failures and irregularities identified by the programme are stored and archived according to whether they are alarms or notes.

Operation history menu:



Additional information is stored to help the user or service technician identify any irregularities in system operation. The types of events recorded in operation history are:

Alarms and notes – The controller can store the last 8 alarm conditions detected. Alarms and comments are displayed in a chronological list, with the most recent at the top. Alarms are indicated with the symbol AL, and notes with UW, along with information about the type of problem and the date and precise time at which it occurred.

All new alerts appear on the operation history list alongside an envelope icon, indicating an 'unread' alert that needs the attention of the user or a service engineer. The envelope icon disappears when the alert has been read.

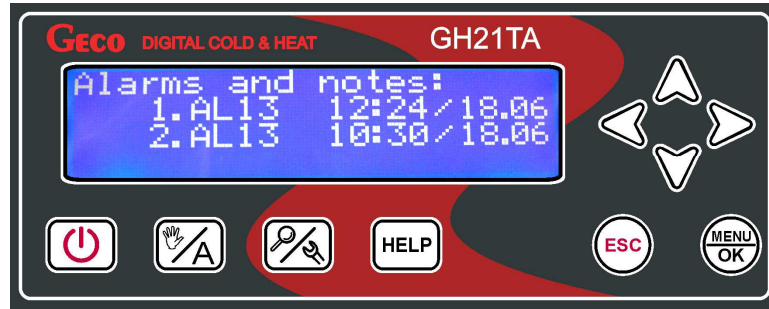

Boiler operating time - The screen shows the operating time, in automatic heating and maintain mode. The time is measured by the hour [h].



Emergency work time - The screen shows safe mode operating time, without breakdown of feeder and fan, measured by the hour [h].

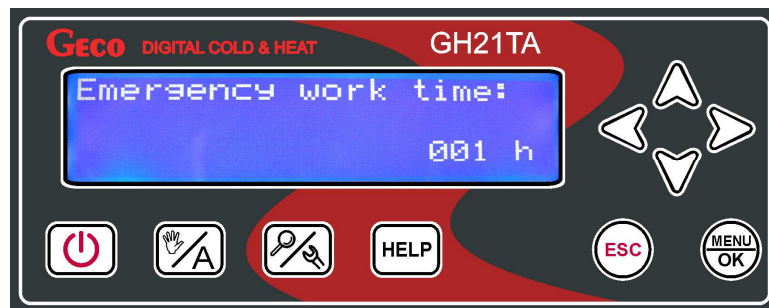

Exceeding maximum temperature - The screen shows the number of times the maximum temperature of 85°C has been exceeded, displayed in number of incidences.



Power supply outage – The screen shows the number of times that power to the controller has failed, displayed in number of incidences.

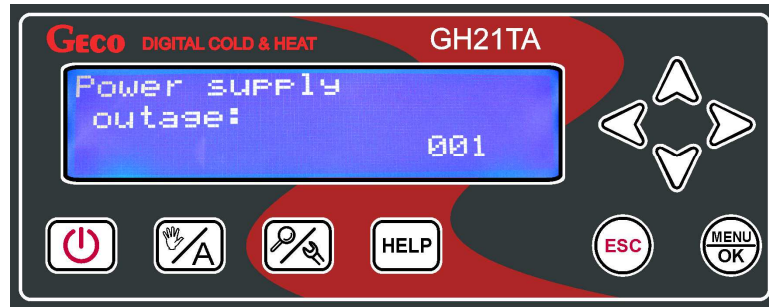

6.6.4 Control panel settings

Settings for the controller, which do not effect heating system operations, can be found in the controller settings panel.

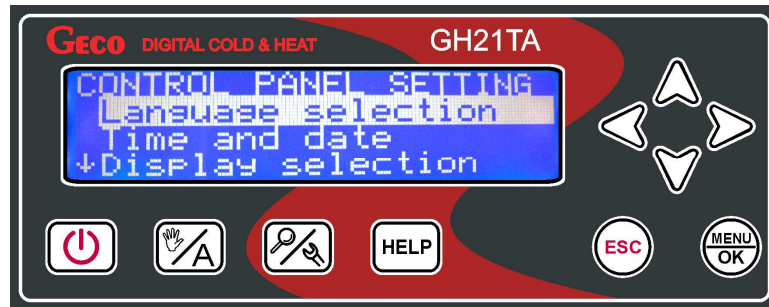

Language selection – The controller allows the user to choose from one of several language settings.

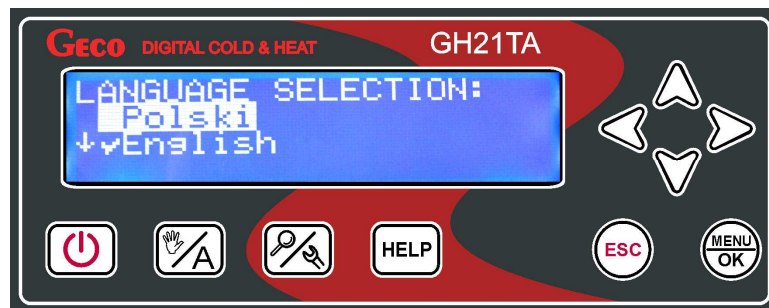

Date and time – In order to ensure that all of the controller functions work correctly and at the optimum level, set the correct time and date.

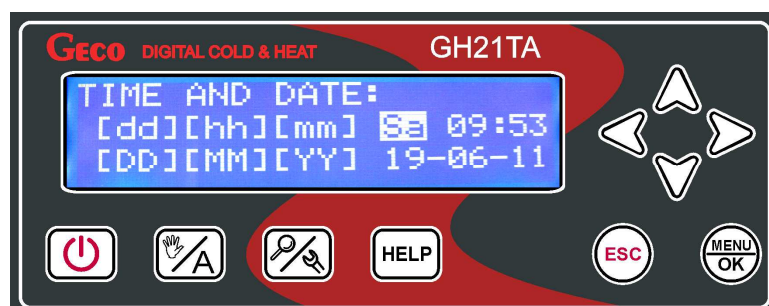

Display selection – The user can set a personal profile screen, and customise the type of information that will be shown. The settings menu offers several choices, with 'standard' set by default.

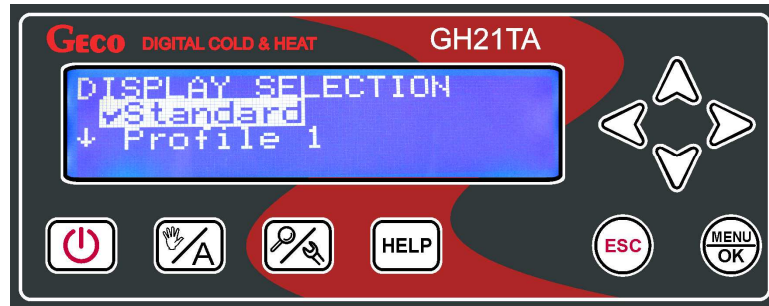

7. Description of additional functions

7.1. DHW priority (hot water)

The GH21TA controller can be set to pump hot water as a priority. If you select this mode, water heating becomes the primary function of the controller, with heating (CH) secondary. This is only available in the second configuration. To enable this function, set the value to "yes" in the menu.

To enable this function, set the value to 'YES' in the main menu.

7.2. Summer function

The GH21TA controller is equipped with a summer mode, which can be used in the summer to turn off the CH pump so that the boiler only heats water. For this function to work, a system installation supporting a DHW pump must be selected. This is only available in the second configuration.

To enable this function, set the value to 'YES' in the main menu.

7.3. Anti-legionella function

The controller is equipped with an Anti-legionella function, aimed at limiting the growth of bacteria of the genus legionella pneumophila in the hot water.

Legionella bacteria develop in aqueous environments, and the optimum temperature for their growth is from 38-42 C. These bacteria also contribute to blockages in hot water systems, hot water heaters and tanks. Legionella bacteria cause a non-specific variant of pneumonia known as Legionnaires' disease, or legionellosis. Legionellosis has been officially recognised by the Ministry of Health as an infectious disease.

The anti-legionella function performed by the GH21TA controller aims to ensure that the hot water tank is not a favourable environment for legionella bacteria.

To activate the function, set the value to 'yes' in the menu.

Duration and operation of this function is shown in system operation preview by negation of the 'LE' symbol. Go to the system operation preview by pressing the button .

This function takes priority over all others, and is the first to be implemented by the controller. When the function is activated, the temperature of water in the boiler is raised to 70 C and maintained for ten minutes. The function can be activated at any time by the user. If, after 120 minutes following activation, the temperature is not reached, the controller switches off the function and displays text information showing that the function could not be implemented. This is only available in the second configuration.



SWITCHING ON THE ANTI-LEGIONELLA FUNCTION WILL INCREASE THE TEMPERATURE OF DOMESTIC WATER TO 70C. USE EXTREME CAUTION WHEN USING HOT WATER TO AVOID SCALDING!!!



7.4. GA03HA room panel

The GH21TA controller is adapted to communicate with GECO's GA03HA room panel, enabling an easy overview of the boiler from the comfort of your home.

Connecting the GH21TA controller to the GA03HA room panel allows:

- Changing the boiler output temperature setting
- Changing the DHW (hot water) or returning temperature setting
- All alarms to be viewed in text format
- Monitoring of the heating system operations
- Monitoring of the operation of devices (fan, feeder, CH pump, DHW pump);
- Monitoring of all temperature measurements



Proper communication between the panel and controller is shown by the icon  on the controller panel, in negation in the system operation preview screen 

If the GA03HA room panel is correctly connected to the controller, it will be automatically detected by the controller and does not require any additional steps or settings from the user.

In this case, the controller works according to settings communicated by the room panel. Disconnecting the room panel or damage to the cable connecting the panel to the controller turns off lights behind the icon  on the screen of the GA03HA room panel.

Follow these steps in order to connect the GH21TA controller to the GA03HA room panel:

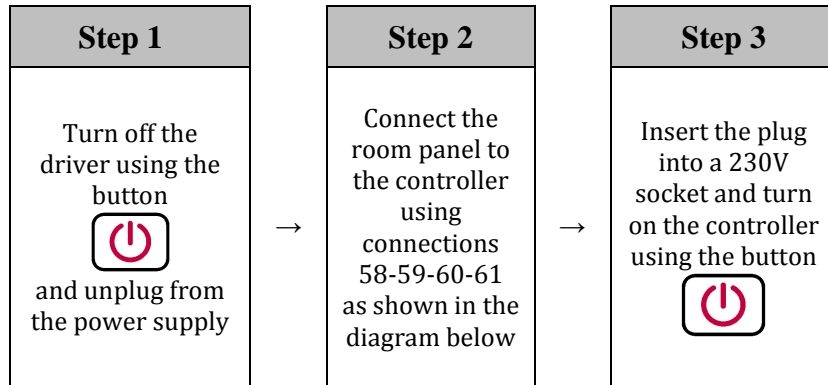

GH21TA Controller strip terminal

GA03HA Room Panel strip terminal

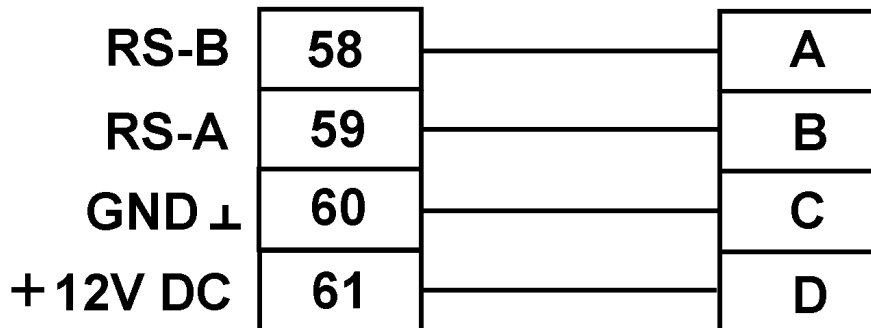

Diagram for connecting the GA03HA room panel to the GH21TA controller

7.5. Fuel feeder temperature detection

The GH21TA controller has the additional option to protect against temperature in the fuel feeder tray rising above the permitted level, preventing the flame from heating the fuel.

Fuel feeder temperature detection works in automatic mode the boiler (Automatic, maintain, alarm). When the temperature measurement exceeds that set in parameter S14, the fuel feeder activates for the duration set in parameter S16, in order to remove lit fuel from the feeder. The fan is turned off for the duration of the time set in S16.

When the time set in parameter S15 expires, the controller regains control of the maximum feeder temperature.

When the feeder $T > S14$, the fan stops, and the fuel feeder is activated for the duration of S16. The controller will display the message U17 'increased temperature in the feeder'.

At the same time, overheating is indicated in preview on the controller, by the backlit negated overheating feeder symbol. . When feeder $T > 90^{\circ}\text{C}$ the fan is stopped completely, the fuel feeder is connected for twice the duration of S16, and the display shows alarm AL11 'maximum feeder temperature exceeded'.



IF S14=0 THE FEEDER SENSOR IS TURNED OFF, AND FEEDER OVERHEATING AND FEEDER TEMPERATURE DETECTION DO NOT WORK.

7.6. Boiler extinguished detection

7.6.1 Out of fuel

If, during automatic mode, the temperature of water from the boiler does not reach that set in parameter S08 for the duration set in S09, the controller records that the boiler has gone out and returns alarm AL13.

7.6.2 Sharp decline in temperature of water leaving the boiler

When in automatic mode the temperature of water leaving the boiler is lower than 10 C and in a short time does not increase by 4 C, the CH pump and hot water pumps are turned off and the controller enters boiler extinguished detection mode.

The controller waits for the time set in parameter S10, to check whether there is an increase of 4 C.

- When this temperature rise DOES occur, detection mode ends, and the heating and hot water pumps are connected.
- When this DOES NOT occur, this means that that fuel has gone out and the controller returns alarm AL13.

7.7. Anti-Stop function

The GH21TA controller includes an anti-stop option, a security measure which guards against system deterioration during the summer months. The function turns on the device for a few minutes every seven days, to ensure performance throughout the year.

There are three settings for this function:

- Standard – all devices in the system, except for the feeder tray
- Complete – all devices in the system
- Inactive – function inactive

The anti-stop function can only be activated in manual mode. When this function is active, the user cannot control devices connected to the system. Manual control of external devices is only possible when this function is turned off.

7.8. Grate mode

The GH21TA controller allows the heating regulation algorithm to be changed to 'grate mode', which does not support the feeder tray. It is usually used when the type of fuel is being changed, for example to wood or green waste paper. The controller operates the boiler, fan and pumps as normal. When this mode is activated the main screen shows the text 'grate mode H' or 'grate-mode M' in heating mode.

This type of regulation can be changed by the user, by changing the parameters of the standard mode in the system. Note that the change should be temporary, and that the system performs optimally only with standard settings. Air supply to the system is provided by a different controller model – GH21NA.

7.9. Pump only mode

The GH21TA controller allows the heating regulation algorithm to be changed to 'pump only' mode. In this mode, neither the feeder nor the fan are supported. It is usually used when the type of fuel is being changed, for example to wood or any other combustible eco-fuel without fan support. The controller only operates the pumps. When this mode is activated, the main screen shows the text 'pump only' in heating mode.

This type of regulation can be changed by the user, by changing the parameters of the system to turn off the standard heating regulation mode. Note that the change should be temporary, and that the system performs optimally only with standard settings. Air supply to the system is provided by a different controller model – GH21NA.

7.10. Operation record

Operation history is where information on all controller malfunctions and custom activities is stored. All failures and irregularities identified by the programme are stored and archived according to whether they are alarms or notes.

Additional information in this function includes details from the boiler manufacturer verifying warranty information, such as number of power failures, exceeding the maximum temperature, etc.

7.11. Emergency work

Safe mode allows the boiler to work in case of damage to the feeder and or fan TRIAC, until servicing is possible. For the controller to operate the feeder / fan in safe mode, the correct mode should be selected from the menu, in addition to changing the feeder/fan connection.

The control signals that it is in safe mode by displaying an exclamation mark in the centre of the bottom of the screen.

8. System installation

8.1 Heating installation number 1

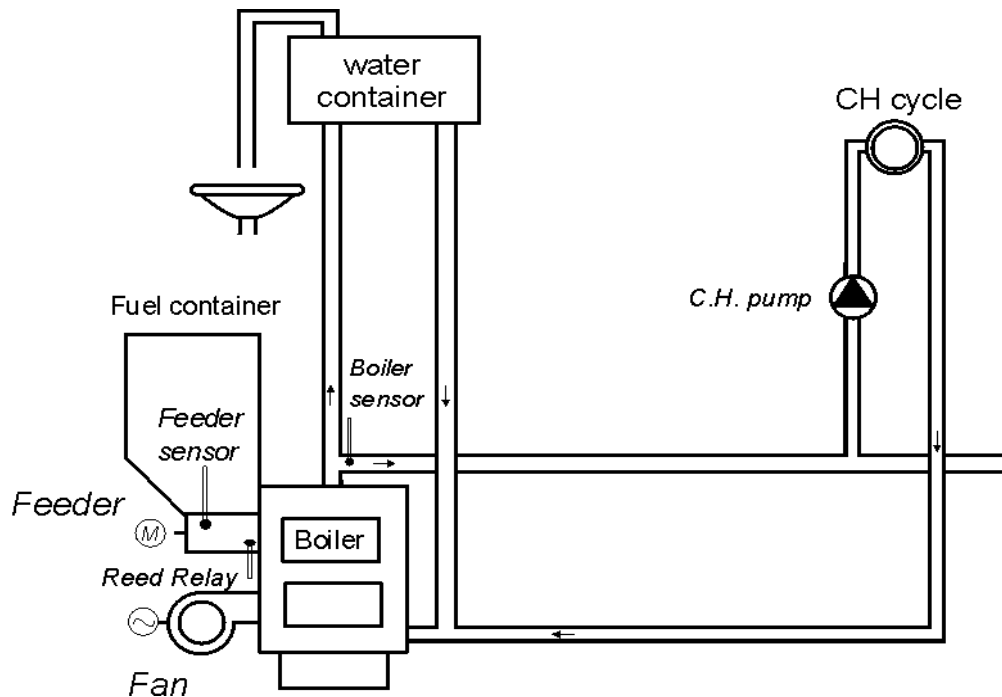

The following list specifies the parameters available to the user, along with the assignment of outputs for attached devices and inputs for temperature sensors.

Diagram 1 - Summary of user parameters		
Parameter	Range	Factory settings
Set temperature of boiler	50 ÷ 85	50°C
Feeder stop time	5 ÷ 250	45s
Maintain time	1 ÷ 250	15min
Fan speed	1 ÷ 10	5
Diagram 1 - Assignment of controller outputs		
Output	Device connected	
05-06	CH pump	
07-08	---	
09-11	Feeder	
12-14	Fan	
Diagram 1 - Assignment of controller inputs		
Input	Description	
50-51	Sensor for water leaving the boiler	
52-53	---	
54-55	Fuel feeder sensor (Optional)	
56-57	Reed relay	
58-59-60-61	GECO GA03HA room panel (Optional)	

8.2 Heating installation number 2

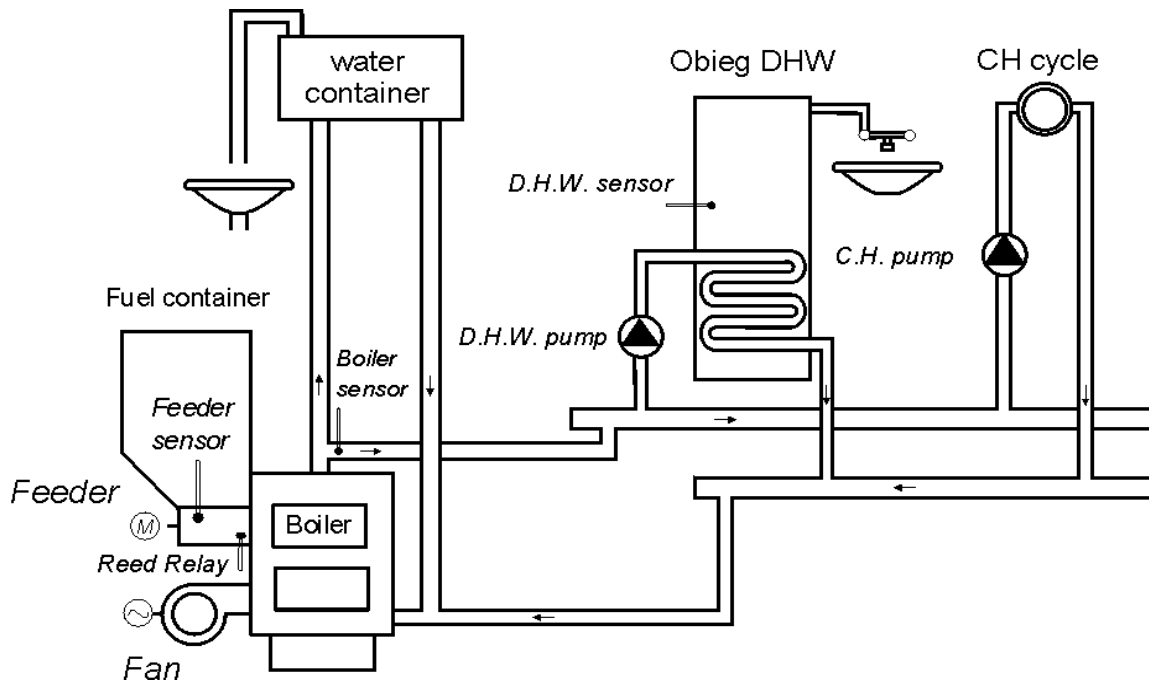

The following list specifies the parameters available to the user, along with the assignment of outputs for attached devices and inputs for temperature sensors.

Diagram 2 - summary of user parameters		
Parameter	Range	Factory settings
Set temperature of boiler	50 ÷ 85	50°C
Feeder stop time	5 ÷ 250	45s
time	1 ÷ 250	15min
Fan speed	1 ÷ 10	5
Set temperature of boiler	35 ÷ 65	40°C
Diagram 2 - Assignment of controller outputs		
Output	Connected devices	
05-06	CH pump	
07-08	DHW pump	
09-11	Feeder	
12-14	Fan	
Diagram 2 - Assignment of controller inputs		
Input	Description	
50-51	Sensor for water leaving the boiler	
52-53	Sensor for water in the boiler	
54-55	Fuel feeder sensor (Optional)	
56-57	Reed relay	
58-59-60-61	GECO GA03HA room controller (Optional)	

8.3 Heating installation number 3

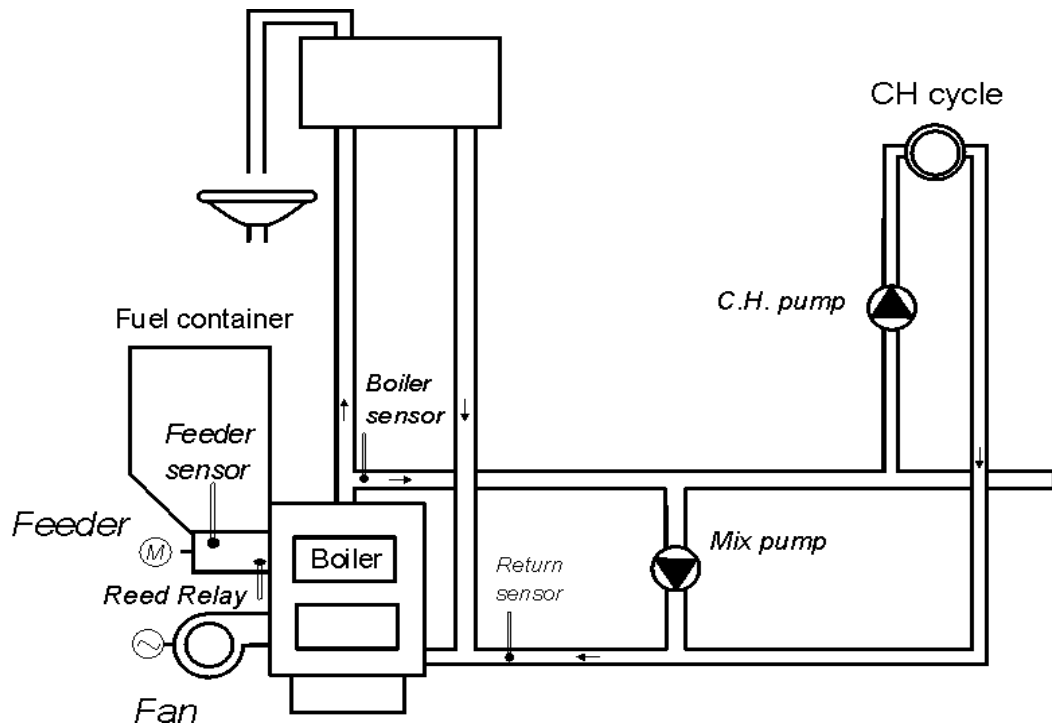



The following list specifies the parameters available to the user, along with the assignment of outputs for attached devices and inputs for temperature sensors.

Diagram 3 - Summary of user parameters		
Parameter	Range	Factory settings
Set boiler temperature	50 ÷ 85	50°C
Feeder stop time	5 ÷ 250	45s
Maintain time	1 ÷ 250	15min
Fan speed	1 ÷ 10	5
Returning temperature	40 ÷ 60	50°C
Diagram 3 - Assignment of controller outputs		
Output	Connected devices	
05-06	CH pump	
07-08	Mixer pump	
09-11	Feeder	
12-14	Fan	
Diagram 3 - Assignment of controller inputs		
Input	Description	
50-51	Sensor for water leaving the boiler	
52-53	Returning water sensor	
54-55	Fuel feeder sensor (Optional)	
56-57	Reed relay	
58-59-60-61	GECO GA03HA room panel (Optional)	

9. Controller algorithms for attached devices

9.1 Heating mode – Fuel feeder



In automatic heating mode with the standard setting, the fuel feeder operates according to the parameters set in 'fuel feeder operation time' and 'fuel feeder interval time'. When the fuel feeder is switched on and operating, this is indicated by a feeder icon in the negated backlit position in system operation preview. . When the feeder is switched off and disabled, this is indicated by a feeder icon without negated backlight in the system operation preview .

9.2 Automatic mode – CH pumps



In automatic heating mode, the CH pumps are connected if the temperature of water in the boiler is greater than or equal to the value set in parameter S06 (the default is 40°C). When the CH pumps are operational, this is indicated by a CH pump icon, in the negated backlit position in system operation preview .

The controller disables the pumps if the water temperature in the boiler drops to the pump activation temperature minus 4°C. (If the activation temperature is 40°C, the pumps will be disabled at 36°C). When the CH pumps are disabled, this is indicated by a pump icon without negated backlight in the system operation preview .

9.3 Heating mode - fan

In automatic heating mode set to standard, and in grate mode, the fan works all the time trybie automatycznym GRZANIE w trybie regulacji standardowej i trybie ruszt wentylator pracuje cały czas, until the temperature reaches that set by the user in the parameter 'set boiler temperature'. During this time, the fan works at the speed set in the parameter 'fan speed'. Connection and operation of the fan is indicated by a fan icon, in the negated backlit position in system operation preview . When the fan is disabled, this is shown by a fan icon without negated backlight in the system operation preview .

9.4 Automatic mode – DHW/Mixer pump

The DHW pump is activated when the temperature of water from the boiler is higher than 40°C and higher than the temperature of the water in the boiler (so as not to cool the water in the boiler), and lower than the temperature set by the user in the parameter 'set DHW temperature'. When the DHW pump is connected and operating, this is indicated by a DHW pump icon in the negated backlit position in system operation preview . When the pump is disabled, this is indicated by a DHW pump icon, without negated backlight in the system operation preview .

9.5 Maintain mode – fan and feeder

The controller enters this mode, if the temperature of the boiler reaches the value set by the user in the parameter 'set boiler temperature'. The fuel feeder and fan are disabled in this mode, for the time set by the user in the parameter 'maintain time'. After this time, the controller turns on the fan and feeder for the time set by the manufacturer in parameter S20.

The fan will operate for longer than the time set for the fuel feeder in parameter 18, in order to light the fuel. The controller exits 'maintain mode' and returns to 'heat mode', if the boiler temperature drops to a value equal to 'set boiler temperature' - boiler hysteresis. The CH pump works the same as in the heating mode.

10. Alarms

The controller has 11 alarms, including eight which will stop the controller for safety reasons and three that are warnings. For each alarm or notes, the number is displayed, along with text information describing the problem, and an audible alarm will sound. When multiple alarms occur, the details are displayed cyclically.

Exiting the alarm is only possible by pressing the button , with the exception of alarm AL12 (overheating boiler), which the controller automatically exits when the temperature falls below the value set in S17, 4°C. When the user accepts conditional operations, the alarm is switched off but is activated again every time the controller is turned on.

Types of alarm

- **AL1** → Blown fuse/temperature limiter tripped
- **AL2** → Damage of water outlet boiler temperature sensor
- **AL3** → Damage to fuel feeder temperature sensor
- **AL4** → damage to DHW/returning water temperature sensor
- **AL9** → Fuel feeder not turning/ damage to reed relay
- **AL11** → Maximum fuel feeder temperature exceeded
- **AL12** → Overheating boiler
- **AL13** → Boiler extinguished

Type of notes (warning):

- **UW4** → damage to DHW/returning water temperature sensor
- **UW10** → Anti-Legionella function notexecuted
- **UW17** → Elevated temperature in fuel feeder

Alarm 1 – Blown fuse/temperature limiter tripped

This alarm occurs when the controller detects a zero signal from the power supply for two seconds. This may be caused by a blown fuse or tripped temperature limiter.

Button  – goes to service data, and the controller is stopped.

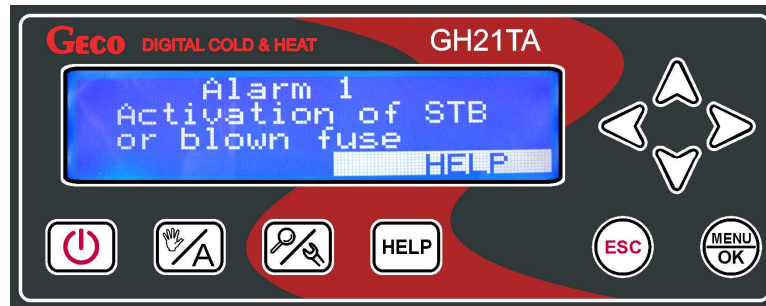

Alarm 2 - Damage of water outlet boiler temperature sensor

This alarm occurs when the NTC 2.2k sensor for testing the temperature of water from the boiler is damaged or not properly connected.

Button  – goes to service data, and the controller is stopped.

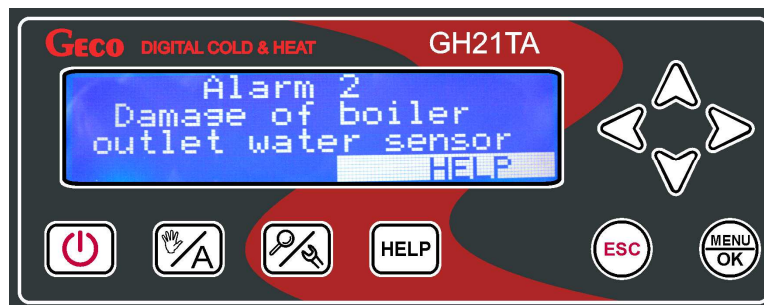

Alarm 3 - Damage to fuel feeder temperature sensor

The user can force safe mode when the fuel feeder temperature sensor is damaged. Safe mode operation will continue until the controller is turned off, or the power is cut. After one of these events the controller returns to manual or automatic mode, determines that the sensor is faulty, and stores this as an alarm, so the operator must force safe mode again. In save mode, the controller will continue to operate without the fuel feeder temperature sensor.

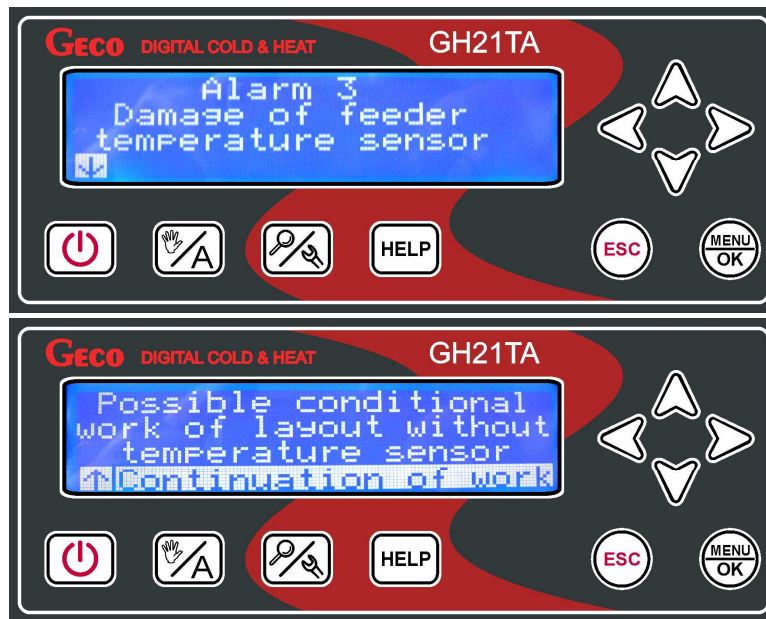

Button  – continues operation in safe mode

Alarm 4/Note 4 - Damage to DHW/returning water temperature sensor

Stan The alarm occurs when the NTC 2.2k NTC DHW/returning water temperature sensor is damaged or not properly connected. It occurs only when the heating configuration includes an additional DHW/Mixer pump.

When the service parameter 'S49' = 0, the alarm is reported as AL4. After confirmation by the user, the boiler can work in safe mode without the DHW/returning water temperature sensor.

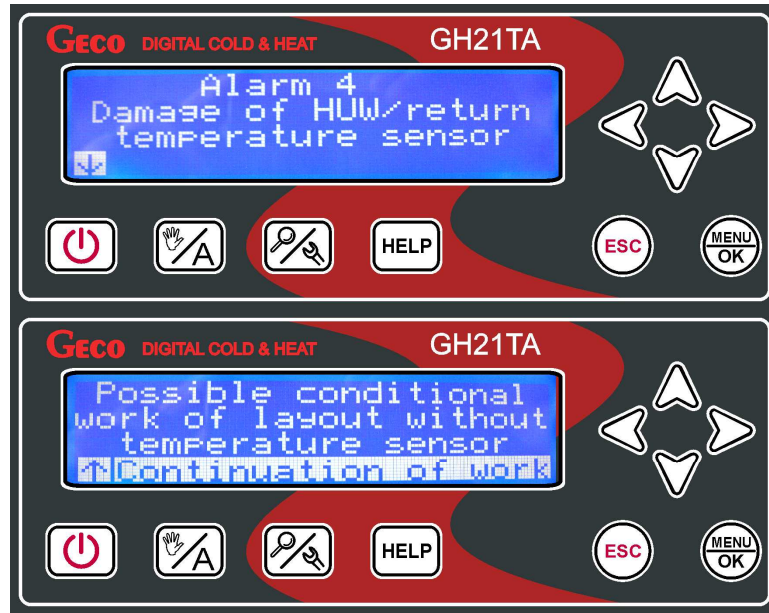

When parameter 'S49' = 1, note UW4 occurs, then the controller switches to safe mode and the boiler operates without the DHW/returning water temperature sensor.

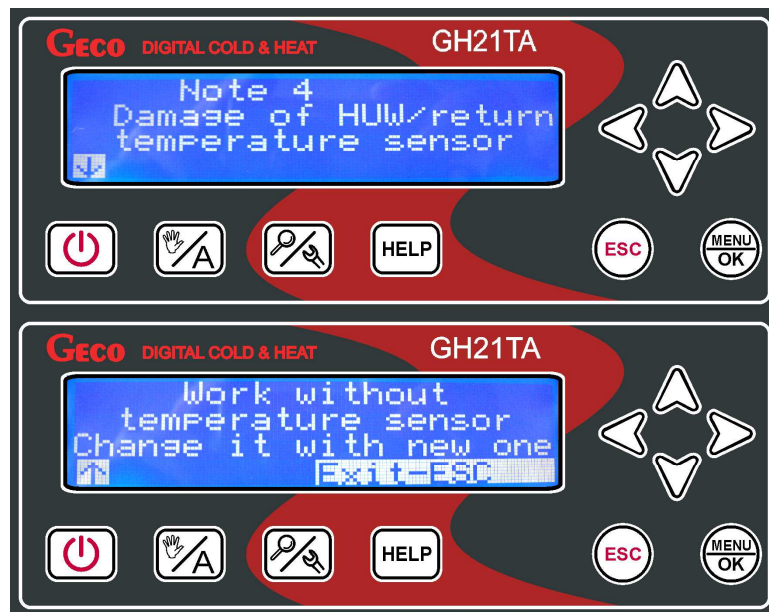

Operating in safe mode without a working DHW sensor reduces the boiler temperature to 65° C and control of the DHW pump operates according to the setting of service parameter S51. During safe mode, the DHW priority and Anti-legionella functions are not available. In safe mode without working returning water sensor, the mixer pump is switched off until the sensor is replaced.

Alarm 9 - Fuel feeder not turning/ damage to reed relay

The controller shows an alarm when no feeder rotation is detected, according to the sensor value in the service parameters. The alarm is activated when the time between the pulses of the reed relay is greater than $1.25 \cdot 'S19' \cdot 'S22'$ [0.1s]. Safe mode operation continues until the controller is turned off or power is cut. After this, the controller determines the damage to the reed relay, and stores this as an alarm, so the operator must force safe mode again. In safe mode, the controller will continue to operate ignoring the reed relay input, as if the sensor had been turned off (S19)=0.



Note 10 - Anti-legionella function not executed

This note occurs only when the heating system is configured with an additional DHW pump and when the Anti-legionella function is activated. The warning occurs when the temperature in the boiler does not reach 70°C within 120 minutes of activation of the function.

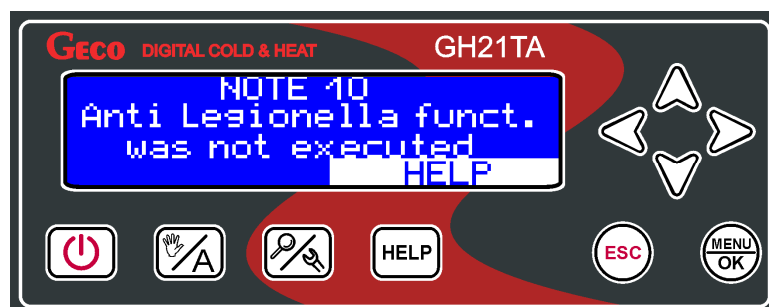

Alarm 11 - Maximum fuel feeder temperature exceeded

The controller shows an alarm when no feeder rotation is detected, according to the sensor value in the service parameters. - 'S14' > 0. The alarm is activated when the temperature ' T_{feeder} ' exceeds 90°C.



Alarm 12 - Overheating boiler

This alarm occurs when the temperature of water coming from the boiler exceeds that set in parameter - 'S17' [°C].

If the temperature of water from the boiler drops to four degrees below that set in 'S17', the controller returns to work in manual or automatic mode, depending on how it was operating before alarm AL12 was activated.



Alarm 13 – Boiler extinguished

The conditions for this alarms operation are checked when service parameter 'S8' > 0 or 'S10' > 0. A detailed description of the operation of boiler extinguished detection function is in Section 7.6.



Note 17 – Elevated temperature in fuel feeder

The controller shows an alarm when no feeder rotation is detected, according to the sensor value in the service parameter - '**S14**' > 0. The alarm is activated when the temperature ' T_{feeder} ' exceeds service parameter '**S14**'[°C].

When the value of **S14** is exceeded, the feeder and fan switch to the mode to disperse fuel from the feeder.

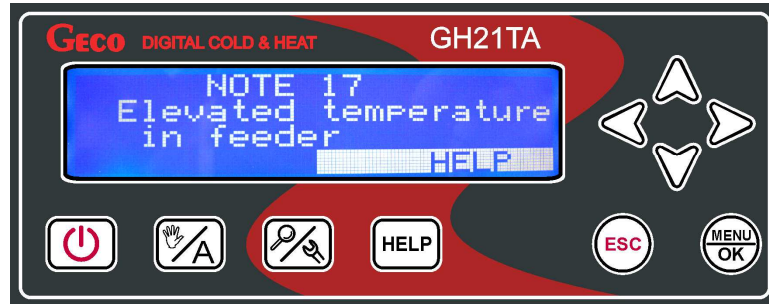

11. Emergency work

Safe mode allows the boiler to work in case of damage to the feeder and or fan TRIAC, until servicing is possible.

In order for the controller to operate the feeder/fan in safe mode, the appropriate mode must be chosen from the controller menu for the feeder/fan to be connected to the control module. In safe mode, the feeder must be connected to terminals 9-10 (standard 9-11), and the fan to terminals 12-13 (standard 12-14).

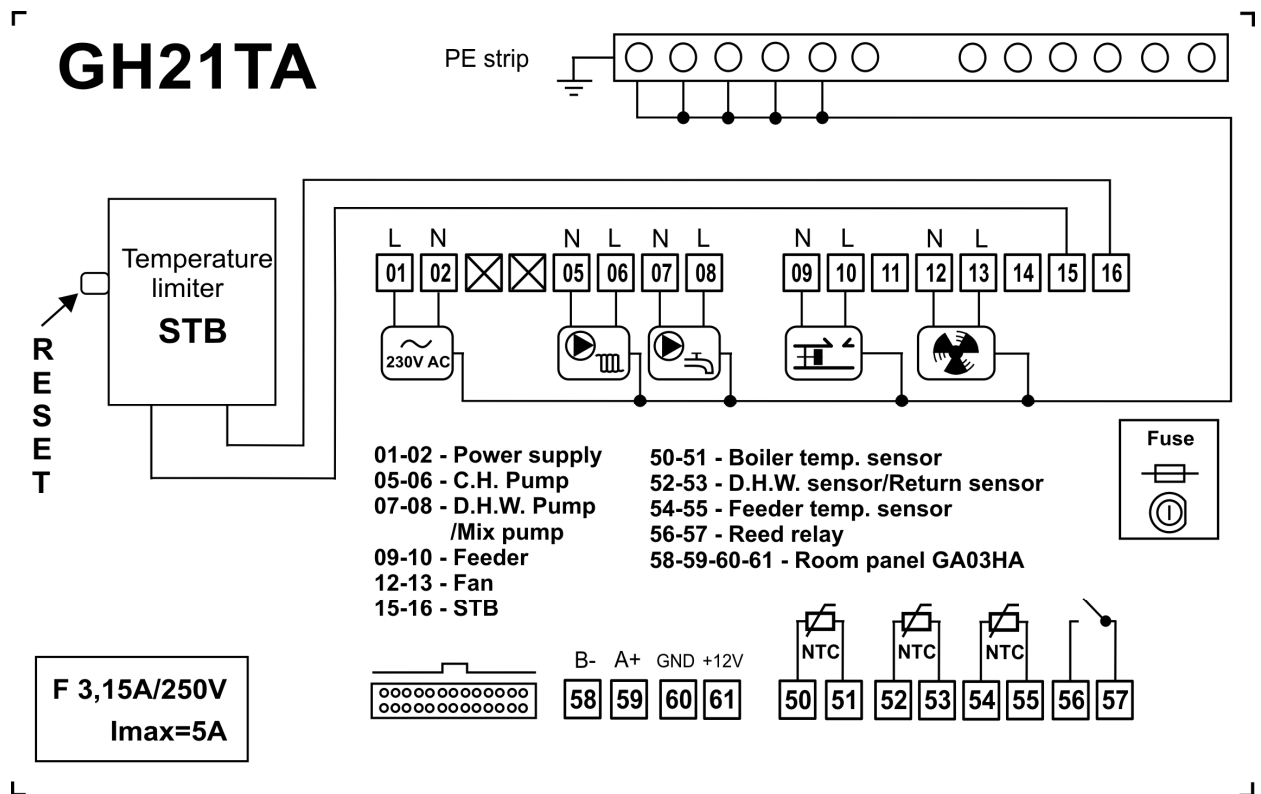

The following table specifies the assignment of outputs for connected devices, in safe mode

Safe mode - assignment of controller outputs		
Device connected	Type of output	Controller terminal
Feeder	Relay	9-10
Fan	Relay	12-13



Devices may only be connected to the GH21TA controller by a qualified wiring technician



During safe mode it is not possible to regulate the speed of the fan

12. Temperature limiter (STB).

Regulator The GH21TA controller is equipped with an independently operating, automatic safety device called a temperature limiter (STB).

12.1. How it works

If the water temperature reaches 95C, the temperature limiter automatically stops the flow of fuel and air to the combustion chamber (the fuel feeder and fan are turned off). When the temperature drops to around 20°C it is possible to manually reconnect

12.2. Reconnecting STB function

To restart the unit, press the 'reset' button, on the left hand side of the controller.





Ogranicznik temperatury (STB)

przycisk RESET

For safety reasons, the boiler does not automatically return to operation after the STB has been tripped.

To turn the controller on again, double click the button 

- The first click of button  will cancel the alarm and turn off the controller
- the second click of button  will reactivate the controller
- pressing button  - puts the controller into automatic mode



Puncture or damage to the capillary of the temperature limiter indicates a leakage, which can lead to the GH21TA malfunctioning.

In this event, disconnect the temperature limiter from the GH21TA controller, and replace it with a new device.

13. Loss of power

After loss of power, the controller will return to the state it was in before the power was cut:

- If it was turned off, it will remain off
- If it was in preview mode, it returns to this state
- If it was in automatic mode, it will return to automatic mode according to preset parameters
- If it was in manual mode, it will return to manual mode, according to preset parameters
- If it was in alarm mode, it will remain off

14. GH03HA room panel

The GH21TA controller is fully compatible with the GECO GA03HA room panel, allowing the boiler to be operated from the comfort of your home.

When the GH21TA controller is connected to the GA03HA room panel, it is possible to:

- Change the set boiler temperature
- Change the set DHW temperature
- Monitor text information about all alarms
- Monitor boiler operation status
- Monitor the status of connected devices (feeder, fan, CH pump, DHW pump)
- Monitor all temperature measurements
- Monitor operation history, including all alarms and notes.
- See information about current additional functions of the controller.

Proper communication between the controller and room panel is indicated by an illuminated LED under the icon on the GA03HA room panel 



Proper communication between the room panel and controller is shown on the controller in system operations preview when the panel icon is lit



If the GA03HA room panel is correctly connected to the controller, it will be automatically detected and does not require any additional steps or settings from the user. In this case, the controller works according to the settings on the room panel.

Disconnecting the room panel (interrupting communication) or damage to the cable connecting the room panel and the controller turns off the light under the icon  on the GA03HA room panel screen, and shows that the function has been disabled, in the system operations preview.

In order to connect the GH21TA controller to the GA03HA room panel:

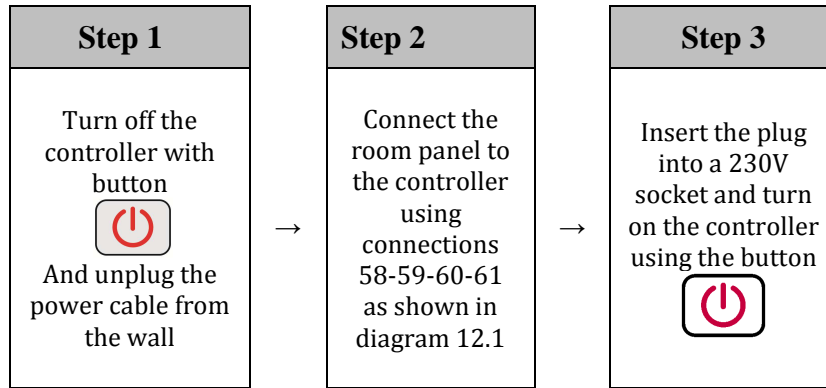

GH21TA Controller strip terminal

GA03HA Room Panel strip terminal

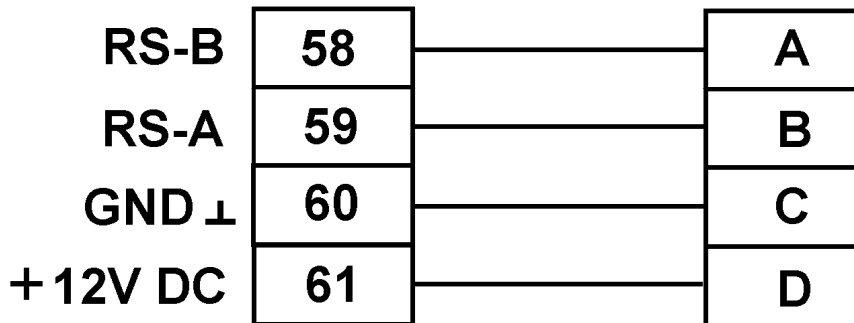

Diagram 12.1 connecting the GA03HA room panel to the GH21TA controller

15. In case of damage to the controller

If the controller malfunctions, contact the supplier/manufacturer of the boiler, or GECO, for technical advice. If the controller needs to be repaired or serviced, remove it completely from the boiler and send it along with its housing to the specified address.



Sending an incomplete controller for servicing automatically invalidates the warranty

Preparing to send the controller for servicing

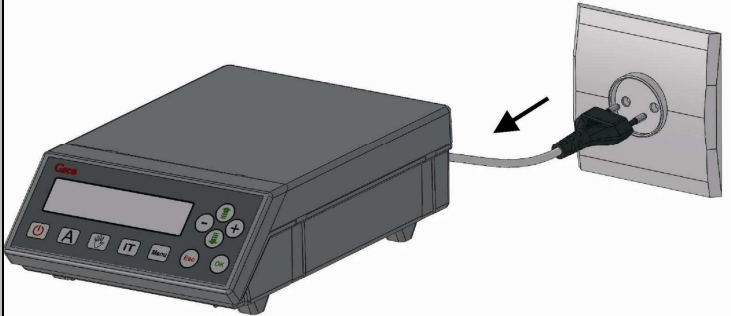
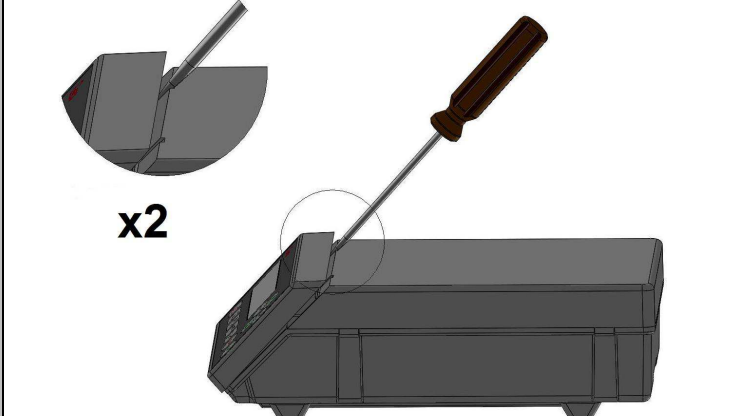
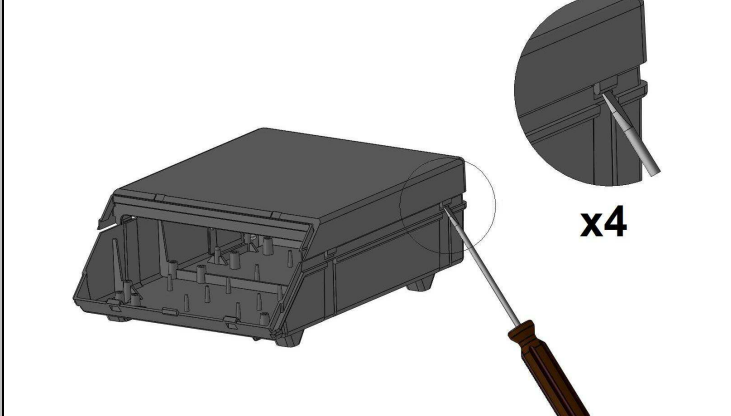
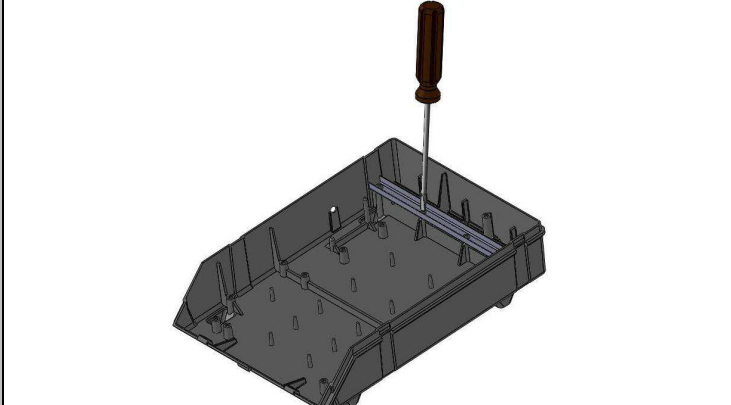
<p>Step 1</p> <p>Disconnect the controller from the power supply (unplug from the wall socket)</p>	
<p>Step 2</p> <p>Remove the front panel using a flathead screwdriver</p>	
<p>Step 3</p> <p>Remove the housing cover using a flathead screwdriver</p>	
<p>Step 4</p> <p>Disconnect the wires from the terminals, remove the cables from the sheaths, loosen the cable clamp strip and remove all cables from the outside of the controller.</p>	

Step 5

Remove the controller from the boiler by unscrewing the 4 screws in the lower part the controller housing

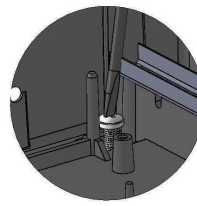

x4

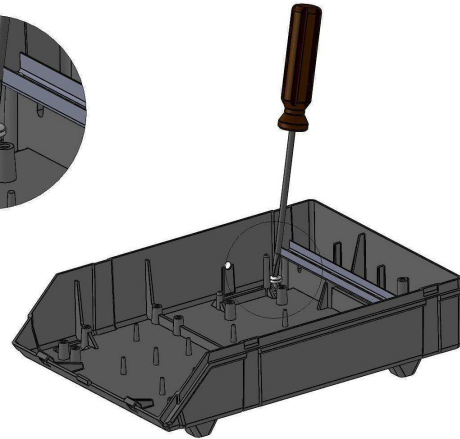

Step 6

Replace the top cover of the housing and front panel

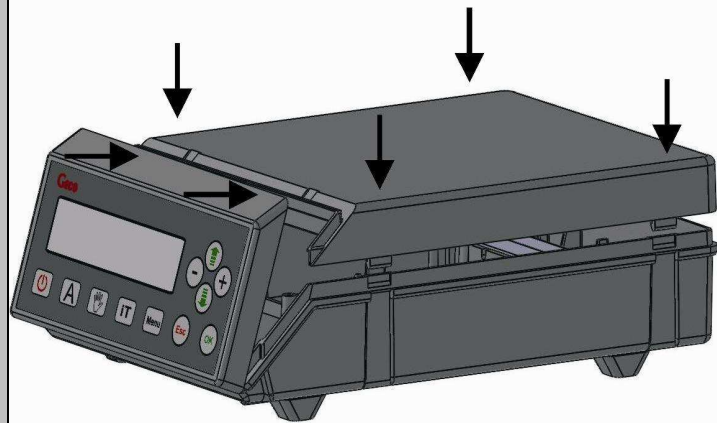

16. Information regarding the labeling and disposal of waste electronic and electrical equipment

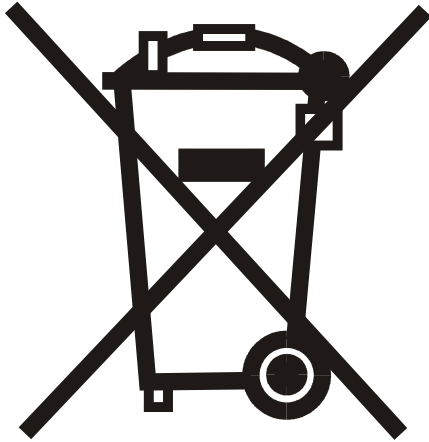

Warning!

This symbol on the product or on its packaging indicates separate collection of waste electrical and electronic equipment. This means that the product should not be disposed of with other household waste. Proper disposal of old and used electrical and electronic equipment will help prevent potential negative effects on the environment and on human health. The user is obliged to arrange the separation and disposal of equipment, which should be given to a collector of used equipment.



GECO[®]

P.P.U.H. „Geco” Sp. z o. o.
32-060 Liszki, Poland
Cholerzyn 376
tel. 012 6369811, 6361290
fax. 012 6362002
<http://www.geco.pl>