

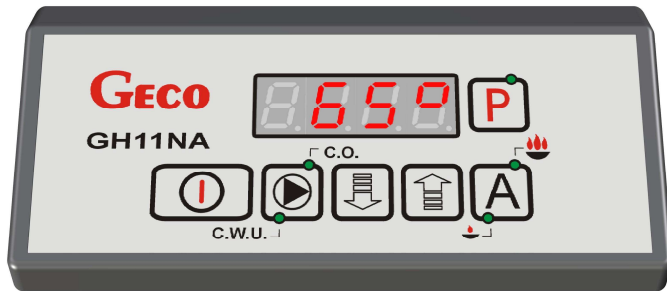

GECO[®]



***INSTRUCTION OF
CONTROLLER
OPERATION***

GH11NA

***FOR CONTROLLING CENTRAL
HEATING BOILERS WITH
AIR BLOW***

***Program version
01***

USER MANUAL

We request that users carefully study applicable Instructions before connecting and starting up any of our products. *Should any doubts arise, please contact our Company between 8 a.m. and 4 p.m.*

TABELLE OF CONTENTS

1. INTRODUCTION	3
1.1. GRAPHIC SYMBOLS.....	3
1.2. KEYBOARD AND FUNCTION KEYS	4
2. GENERAL FEATURES.....	4
3. TECHNICAL DATA.....	5
4. ELECTRICAL SYSTEM AND CONNECTION RULES.....	6
5. QUICK START	6
6. THE GH11NA OPERATION	7
6.1. OPERATED HEATING SYSTEM	7
6.2. AUTOMATIC OPERATION MODE.....	8
6.3. MANUAL OPERATION MODE	10
6.4. VIEWING TEMPERATURES.....	10
6.5. ALARM CONDITIONS	11
6.6. POWER OUTAGE.....	11
6.7. BOILER BURNOUT DETECTION.....	11
7. USER SETTINGS.....	12
7.1. BOLIER TEMPERATURE SETTING (U0)	12
7.2. FAN SPEED (U1)	13
7.3. HUW/ RETURN TEMPERATURE SETTING (U2).....	13
7.4. ANTI-LEGIONELLA FUNCTION (U3)	13
8. OPERATING THE HUW BOILER.....	14
8.1. INSTALATION AND CONNECTIONS	14
8.2. CONFIGURATION OF ADDITIONAL PUMP.....	15
8.3. HUW PRIORITY.....	15
8.4. SUMMER MODE.....	15
8.5. ROOM PANEL GA01HA - GECO	16
9. TEMPERATURE LIMITER (STB)	17
9.1. OPERATION PRINCIPLE	17
9.2. STB FUNCTION RESTART (MANUAL)	17
10. PROCEDURE IN THE CASE OF CONTROLLER DAMAGE	18
11. CONNECTION DEVICES TO THE GH11NA CONTROLLER	21
12. INFORMATION ON LABELLING AND COLLECTION OF WORN OUT ELECTRICAL AND ELECTRONIC EQUIPMENT	22
13. NOTES.....	23

1. INTRODUCTION

1.1. Graphic symbols

Symbols intended to indicate and at the same time emphasise the importance of text containing information that warns against dangerous situation have the following graphic forms:



Warning

This symbol is used when it is necessary in described instructions to follow the sequence of carried out operations. The unit may be damaged or destroyed in case of any error or proceeding in discord with the description.



Important!

This symbol indicates information of particular importance.



Reference

This symbol indicates occurrence of additional information in a chapter

1.2. Keyboard and Function Keys

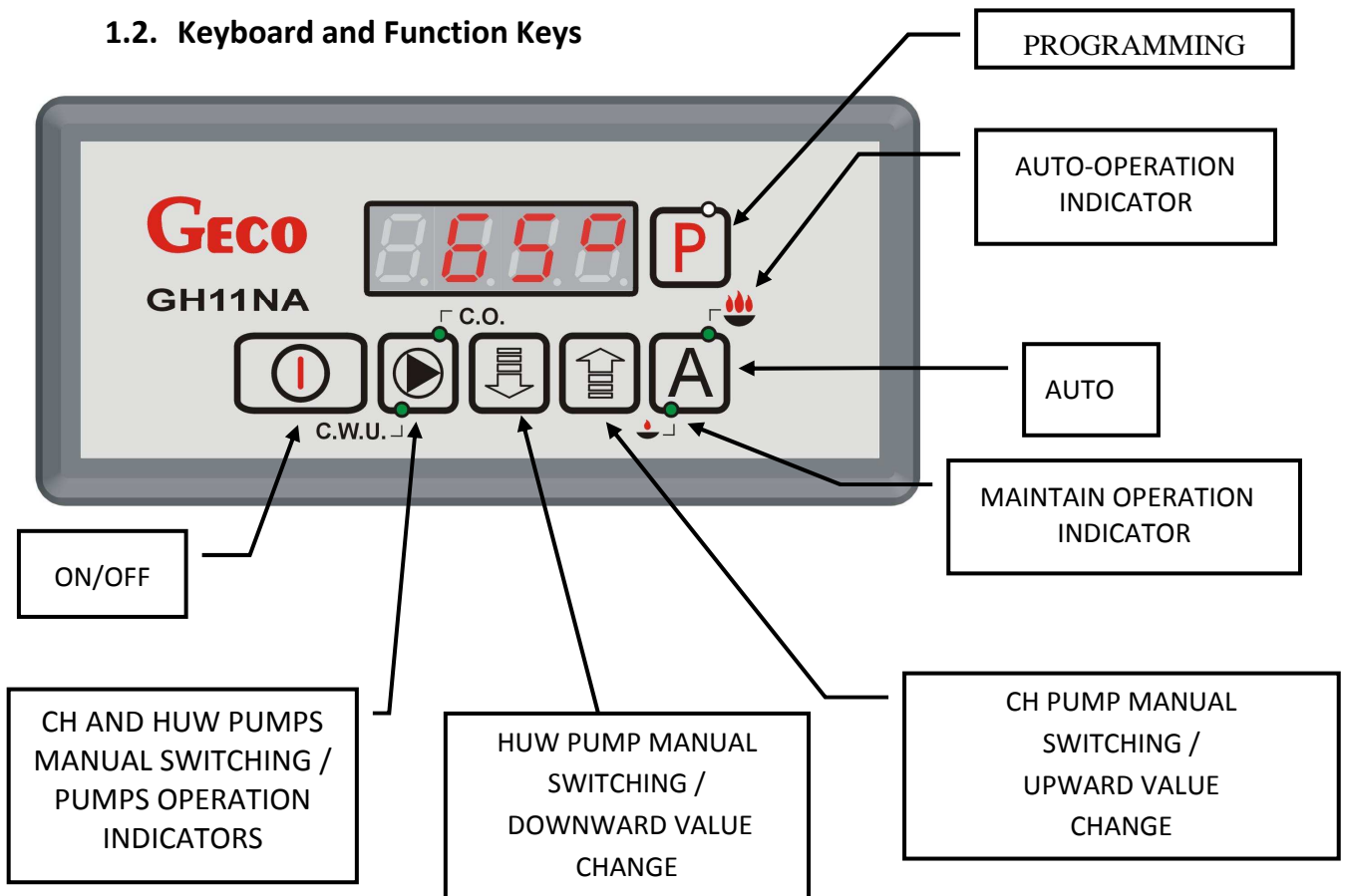

2. GENERAL FEATURES

The GH11NA Controller is a microprocessor-based device manufactured using the Surface Mount Technology (SMT).

It is designed to control the processes of Hot Utility Water (HUW) heating and the main Central Heating (CH) water circuit. Control parameters can be adjusted to the current operating conditions and boiler type. The Controller includes a system protecting from power outages and other different disturbances.

The GH11NA Controller is fitted with:

- inputs:
 1. Boiler output water temperature measurement (NTC sensor),
 2. HUW boiler water /return water temperature measurement (NTC sensor),
 3. Flue gas temperature sensor in chimney (PT1000 sensor),
- digital input:
 4. Input for connection of the room thermostat panel GA01HA-GECO.

It also contains four outputs allowing direct connection of 230 V AC devices: fan, CH circulation pump, HUW pump or mixing pump, depending on the type of the controlled heating system (⇒ section 6.1.1 p.6).



**ALWAYS DISCONNECT THE CONTROLLER
FROM POWER DURING THUNDERSTORMS**

3. TECHNICAL DATA

Power supply	230V ~ +10% -15%	
Operating temperature range	+5°C to +40°C	
Humidity	20% to 80% RH	
Fan protection	3,15A	
Sensors type	NTC 2,2kΩ; PT1000	
Sensors operating temperature range	NTC:	0°C÷100°C
	PT1000:	0°C÷750°C

Output	Maximum continuous load	
	Current (A)	Power (W)
HUW pump / mix pump	1A	200W
CH pump	1A	200W
Fan	1A	200W

NTC sensor resistance characteristics	
Temp. °C	Resistance Ω
0	7174,89
10	4374,83
20	2747,10
30	1774,91
40	1172,09
50	795,08
60	547,95
70	384,62
80	275,86
90	202,37
100	149,16

PT1000 sensor resistance characteristics	
Temp. °C	Resistance Ω
0	1000,00
50	1194,00
100	1385,10
150	1573,30
200	1758,60
250	1941,00
300	2120,50
350	2297,20
400	2470,90
450	2641,80
500	2809,80
550	2974,90
600	3137,10
650	3296,40
700	3452,80
750	3606,40

4. ELECTRICAL SYSTEM AND CONNECTION RULES

1. The boiler room should be equipped with a 230V/50Hz electrical system, according to the applicable regulations.
2. The electrical system (regardless of its type) should be terminated with a connection outlet fitted with a protective terminal. **Use of an outlet without a protective terminal causes electrical shock hazard!!!**
3. Connect the Controller to a separately installed power line protected with a properly selected quick circuit-breaker or a residual-current device (RCD breaker). **Do not connect any other devices to this line!!!**



**THE CONTROLLER IS POWERED FROM 230V/50HZ MAINS
ANY REPAIRS MAY BE CARRIED OUT ONLY WITH POWER SUPPLY**

CUT OFF AT THE FUSE

5. QUICK START

To quickly start the GH11NA Controller, perform the following actions:

1. Connect the device to the 230V AC power system (put the plug in the power outlet).

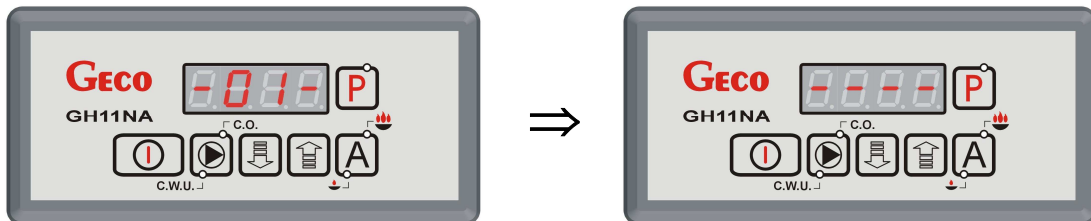

2. Turn the Controller ON by pressing . Screen appears:

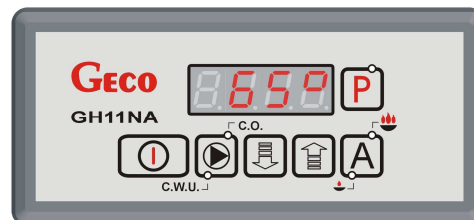

3. Press  . Screen appears:

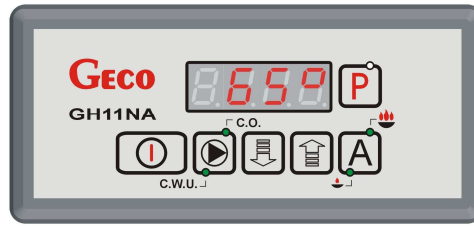

and the Controller starts automatic operation according to the factory settings.

Table 1 Factory settings chart

User parameter	Description	Factory setting
u0	Boiler preset temperature	60 ⁰ C
u1	Fan speed	5
u2	HUW/return set temperature	40 ⁰ C
u3	Anty-Legionella , 1-Yes, 0-No	0

6. THE GH11NA OPERATION

6.1. Operated Heating System

6.1.1. Central Heating cycle + HUW cycle

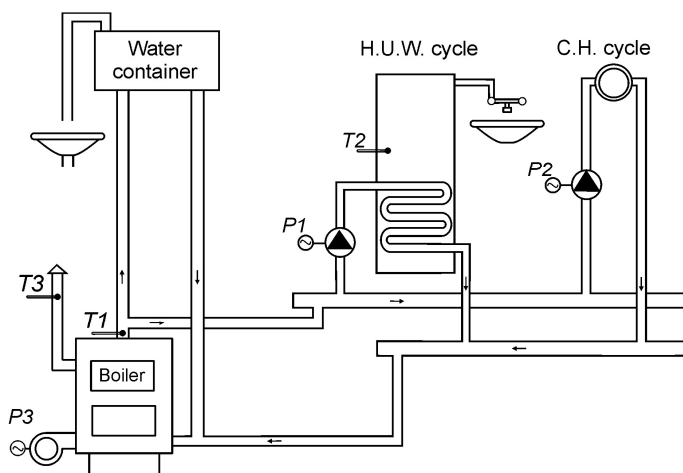

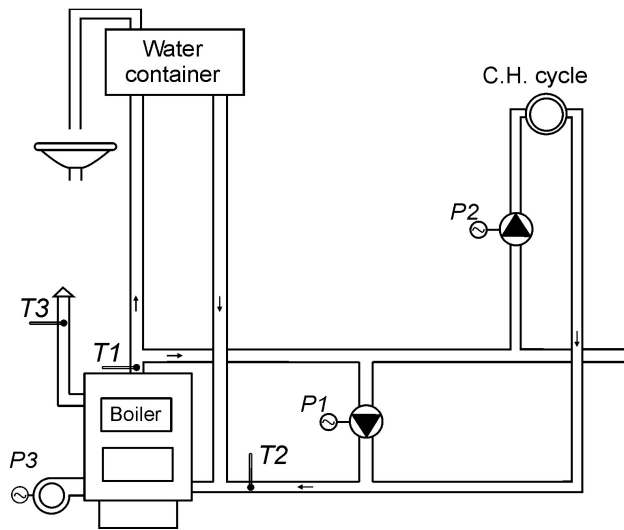

INPUTS	OUTPUTS
T1 – Boiler temp.	P1 – HUW pump
T2 – HUW temp.	P2 – CH pump
T3 – Flue gas temp.	P3 – Fan

6.1.2. Central Heating cycle + mixing pump



INPUTS	OUTPUTS
T1 – Boiler temp.	P1 – Mixing pump
T2 – Return temp.	P2 – CH pump
T3 – Flue gas temp.	P3 – Fan

6.2. **Automatic operation mode.**

By pressing , you can turn on the automatic operation mode – the Controller lights the upper indicator on .

6.2.1. Fan

In the AUTO mode, the fan runs continuously until the boiler temperature reaches the value set by the user in the *u0* setting.

The fan starts with minimal speed (gear 1) and increase its speed according to **F31** parameter until getting to speed set in *U1* parameter (⇒ Table 1).

When flue gas temperature sensor is connected to the controller and it is activated (**F11** > 0), after exceeding flue gas temperature set in **F42** parameter the fan speed is reduced. This reduction is proportionate until the fan stops completely.

Activation and operation of the fan is indicated by means of a vertical line on the left side of the display, in the lower sign segment, on the Controller main display screen.

6.2.2. CH Pump

In the AUTO mode, the CH pump starts when the temperature of the boiler water is higher or equal to the value set in the **F06** service setting (factory setting is 40°C).

Turning the CH pump on and its operation is indicated by lighting the **upper** indicator on .

The Controller turns off the pump when the water temperature drops to the activation temperature minus 4°C. (If the CH pump start temperature is 40°C, then the CH pump stop temperature is 36°C).

6.2.3. Maintain Operation Mode

The Controller gets into that mode when the boiler temperature reaches the value set by the user in the *U0* setting.

This mode of operation is indicated by lighting the **lower** indicator on .

When set temperature is reached and **F32**=0, the fan will be turned on only for periodical blows. The duration of blow is consistent with the value set in parameter **F26**, and the fan works with maximum speed. The air blows take place at the time set in parameter **F27**.

When **F32** > 0 and the outlet water temperature does not exceed the value equal to the *U00* + **F33**, the fan works with speed set in **F32** parameter. The Controller will exit the MAINTAIN mode and return to the AUTO mode if the boiler temperature drops to the value equal to the *U00* – **F05**.

The CH pump operates identically as in the AUTO mode.

6.3. Manual operation mode

Pressing  causes the Controller to switch from automatic to manual mode, and immediately deactivates the fan, and the pump.

In this mode, you can manually and independently activate and deactivate the HUW pump and the CH pump.

To do this, follow the scheme below:

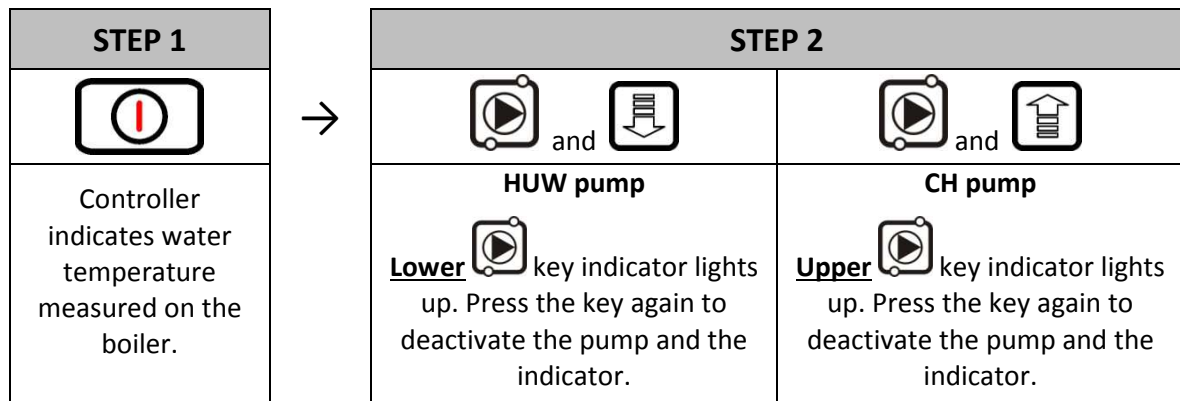

HUW PUMP CAN BE TURNED ON ONLY IF IT IS SELECTED IN SERVICE PARAMETERS (⇒ SECTION 8.2, PAGE 15)

6.4. Viewing Temperatures

After pressing , the display shows water temperature at the boiler outlet. Viewing temperatures: flue gas and HUW/return is available in the AUTO and MAINTAIN modes, but only if the flue gas sensor or HUW/return sensor are properly enabled.

Press  to view the flue gas temperature. Press the key again to cancel the view. The view is also cancelled after 10s from pressing of the key.

Press  to get a HUW/return temperature view. Press the key again to cancel the view. The view is also cancelled after 10s from pressing of the key.

6.5. Alarm Conditions

The Controller uses 6 different alarm conditions. In each alarm condition, the Controller displays the alarm number and activates the alarm sound output. In case of several alarm conditions occurring simultaneously, their numbers are displayed in sequence. You can exit an alarm condition only by pressing



. This does not include the AL12 and AL7 alarm condition.

Alarm conditions:

- **AL1** → STB activated or fuse blown
- **AL2** → Boiler water outlet temperature sensor failure
- **AL4** → HUW/return temperature sensor failure
- **AL7** → Flue gas temperature sensor failure**
- **AL12** → Boiler overheating
- **AL13** → Boiler burnout

****This alarm appear just during viewing flue gas temperature and there is no acoustic signal.**

6.6. Power Outage

After a power outage the Controller starts to reactivate according to the condition it was in before the power down. The Controller waits 1 minute to stabilise the mains power parameters, and then restores operation with the previously programmed settings.

During the waiting period, the display shows time in seconds remaining until the end of the period, along with indication of its condition before the power outage:

- blinking “A” for AUTO mode,
- blinking “P” for SUSTAIN mode,
- blinking “r” for MANUAL mode.

Respective indicators (AUTO  or SUSTAIN ) are blinking along with the letters.

6.7. Boiler Burnout Detection

6.7.1. No Fuel

If during automatic operation the boiler outlet water temperature remains below the F08 setting for a period of time set in the F09 setting, then the Controller considers the boiler as “burned out” and enters the AL13 alarm condition.

6.7.2. Sudden Drop of Outlet Water Temperature

If during automatic operation the boiler outlet water temperature drops by 10°C, and during that dropping period the temperature does not rise by 4°C, then the SH and DHW pumps are switched off, and the Controller goes into the burnout detection mode.

The Controller waits for the period of time set in the **F10** setting, during which it checks whether a rise of 4°C occurs.

If YES, then the burnout detection condition is stopped, and the SH and DHW pumps (if necessary) are started. If NOT, this means that the furnace is burned out – the Controller enters the **AL13** alarm condition.







STOPPING CH PUMP OPERATION IN BURNOUT DETECTION IS INDICATED BY BLINKING THE UPPER INDICATOR ON .

7. USER SETTINGS

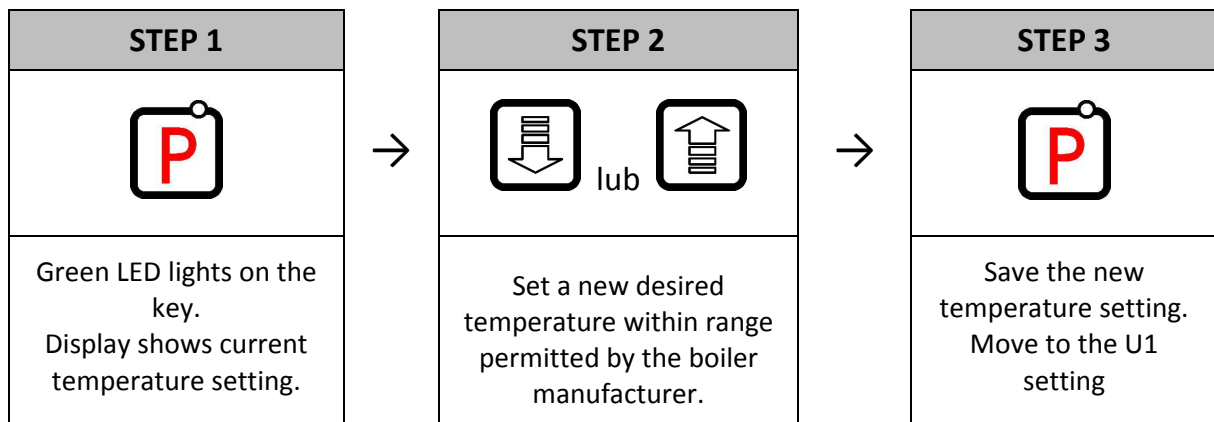
7.1. Boiler Temperature Setting (u0)

You can change the boiler temperature setting using the following procedure:



If during setting the new temperature none of the following keys , ,  is pressed for 15 s, the new temperature will not be saved and the Controller will exit the programming mode.

7.2. Fan speed (u1)

This setting determines the fan rotation speed, and thus the amount of air delivered. It allows to adjust the fan speed according to the type and quality of the fuel used. This setting can be set within the range of 1÷10, where “1” denotes minimum speed, and “10” maximum speed.

You can change the setting using the following procedure:

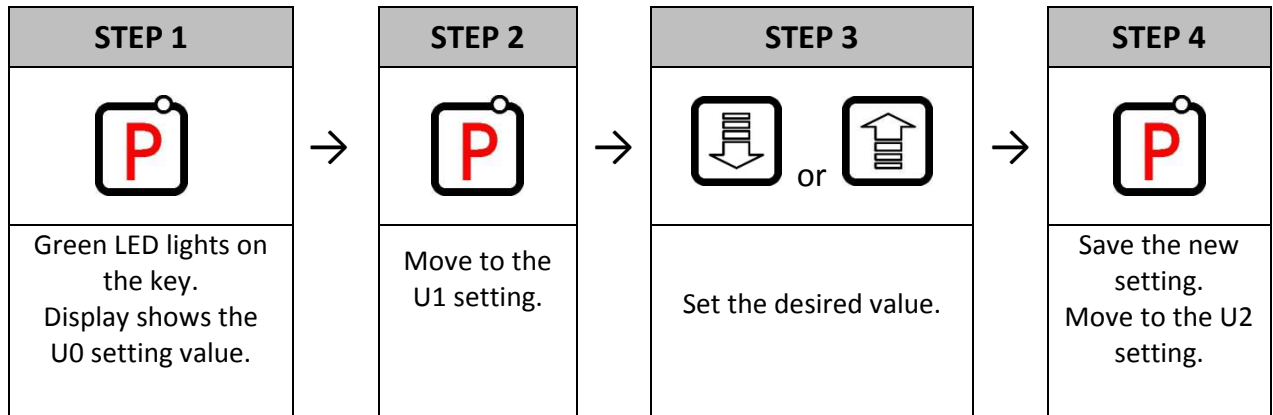

7.3. HUW/ Return Temperature Setting (u2)

This setting is available to the user **only** if the HUW heating option or return temperature stabilisation are used, and the user configured the pump with the **F00** service parameter by setting it to the values “01”, “02”, “03”, “04” (⇒ section 7.2 page 13). You can modify this setting in a similar way to the described in sections 7.1.

7.4. Anti-Legionella Function (u3)

The GH11NA controller is equipment in Anti-Legionella function which limit growth *Legionella pneumophila* bacterium on HUW installation. This function is available for users when value **F00** service parameter was adjust on „02”, „03” or „04”.

The Legionella bacterium growth in water environment and the best condition is on 38–42°C temperature. The Legionella bacterium can cause variety pneumonia disease, called Legion fever.

To activate the ANTI-LEGIONELLA function, set the *U3* setting to 1.

When the function is active, a blinking letter “L” is visible on the left part of the display, before the displayed temperature value.

You can turn off the function by modifying the *U3* setting to 0, or by pressing . The anti-legionella function is also cancelled after a power down. The ANTI-LEGIONELLA function has higher priority over other functions, therefore it is performed by the Controller in the first order (superior function).

When the function is activated, the temperature of water in the boiler is increased to 70°C and maintained for a period of 10 minutes.



TURNING ON OF THE ANTY-LEGIONELLA FUNCTION CAUSES RISE OF THE TEMPERATURE OF HUW WATER UP TO 70°C.

**EXTRA CAUTION WHEN USING HUW.
MAY RESULT IN BURNING !!!**

8. OPERATING THE HUW BOILER

The GH11NA Controller allows connection of an additional pump to control the Hot Utility Water (HUW) in the boiler.

8.1. Instalation and Connections

To use the Hot Utility Water (HUW) heating option, perform the following actions:

1. connect the boiler according to the enclosed diagram (⇒ section 6.1.1 page 7).
2. install the HUW temperature sensor in the HUW storage



We recommend mounting HUW temperature sensor in GECO measuring drain. You can not mount temperature sensors in measuring drain with water or oil !!!

3. connect the HUW temperature sensor to the Controller at the appropriate terminals as shown in Fig. 2
4. configure the HUW pump for operation (⇒ section 7.2 page 13).



HUW temperature sensor is additional equipment and it's not includes to the standard set controller GH11NA.

Additional equipment can be delivery according with additional order.

8.2. Configuration of additional pump

This procedure allows you to connect an additional pump that can be used as a mixing pump or a Hot Utility Water (HUW) pump operating with or without higher priority.

The HUW pump is started when the boiler outlet water temperature is higher than 40°C and higher than the water in the HUW boiler (to prevent cooling of the HUW boiler), and the HUW boiler temperature is lower than the temperature set in the *U2* setting section 5.

Pump operation is indicated by a dot on the display next to the fan symbol. If the boiler room is configured as shown in the diagram (⇒ section 6.1.1 page 7) then the boiler controller has no external alarm output,

but allows to view the HUW boiler temperature by pressing .

Aby załączyć w sterowniku obsługę dodatkowej pompy należy postępować następująco:

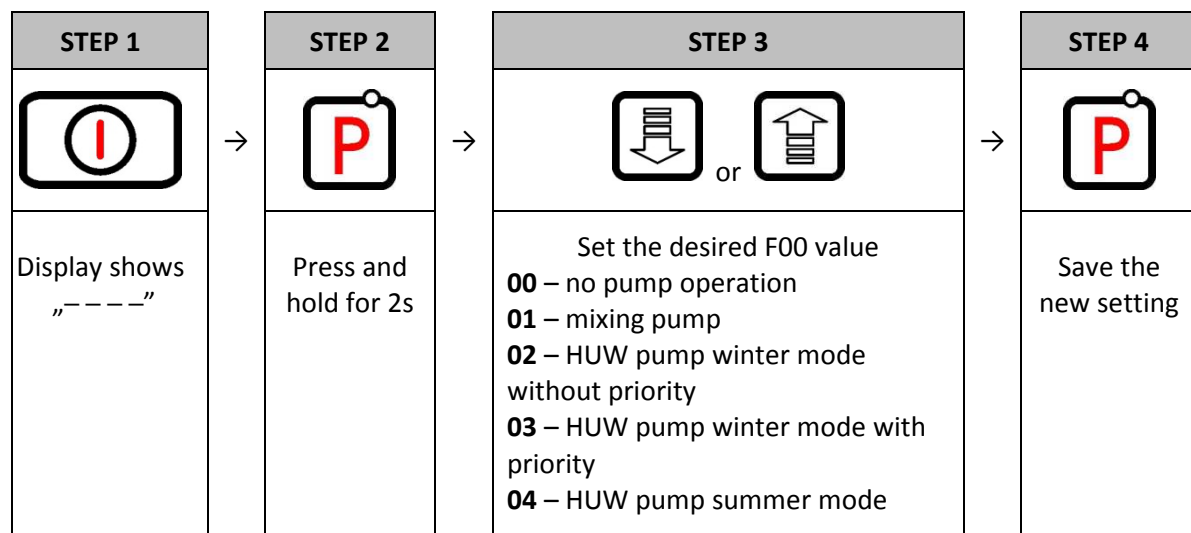

8.3. HUW Priority

The GH11NA Controller allows to set operation of the HUW pump with priority. If you choose this mode of HUW pump operation, the hot utility water heating is a higher priority function in the Controller.

To do this, set the **F00** service setting to the value of “**3**”.

8.4. Summer Mode

The GH11NA Controller is equipped with a SUMMER MODE option that allows you to turn off the CH pump for the summer season, and the boiler operates only to supply the HUW water. To do this, set the **F00** service setting to the value of “**4**”.

8.5. Room panel GA01HA - GECO

The GH11NA controller has been fitted for full communication with the GA01HA room panel manufactured by GECO, which allows to control boiler operation comfortably from user's apartment.

The GA01HA room panel connected to the GH11NA controller allows:

- to change boiler preset temperature
- to change HUW preset temperature
- information on all alarms to be displayed in room panel
- to view boiler operation state
- to view operation states of other units (fan, fuel, central heating pump, HUW pump)
- to view all measured temperature values

If the GA01HA room panel is correctly connected to the GH11NA controller, it will be automatically detected by the controller. Then, user is not required to carry out any additional operations or make any settings.

In this case, the controller will work according to the room panel settings.

Proceed as follows to connect the GA01HA room panel to the GH11NA controller:

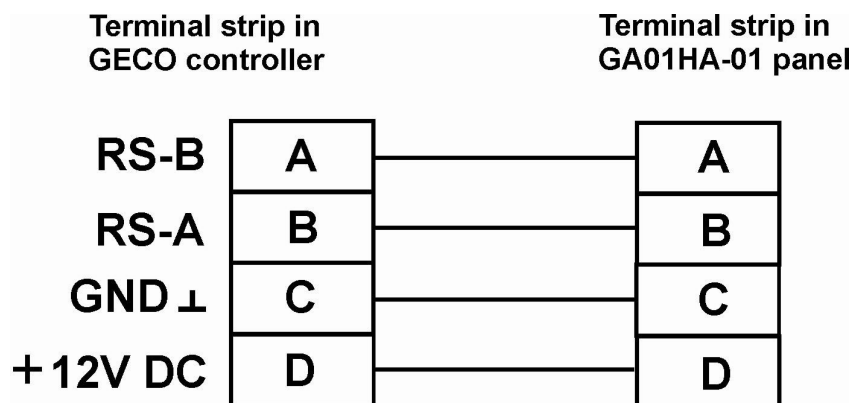
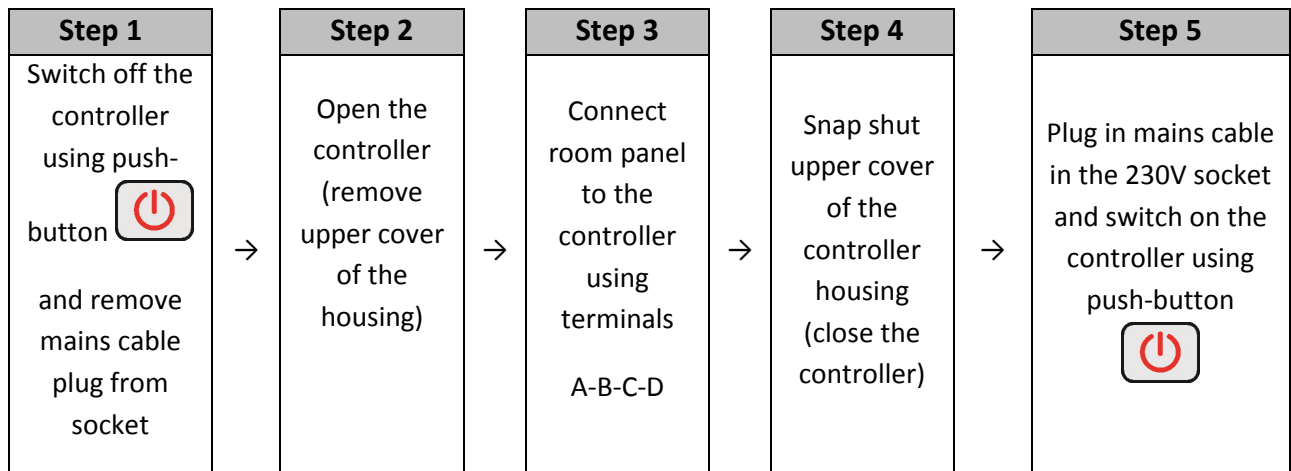

9. TEMPERATURE LIMITER (STB)

The GH11NA controller is provided with an extra mechanical protection, independent of automatic systems. It is called safety temperature limiter (STB).

9.1. Operation principle

In case heating water reaches the temperature of **95°C**, temperature limiter will start working automatically (it will activate the STB function), and interrupt fuel supply and air delivery to combustion chamber (it will switch off the fan).

When temperature in the limiter drops by approximately **20°C**, it will be possible to restart the STB function, but only manually.

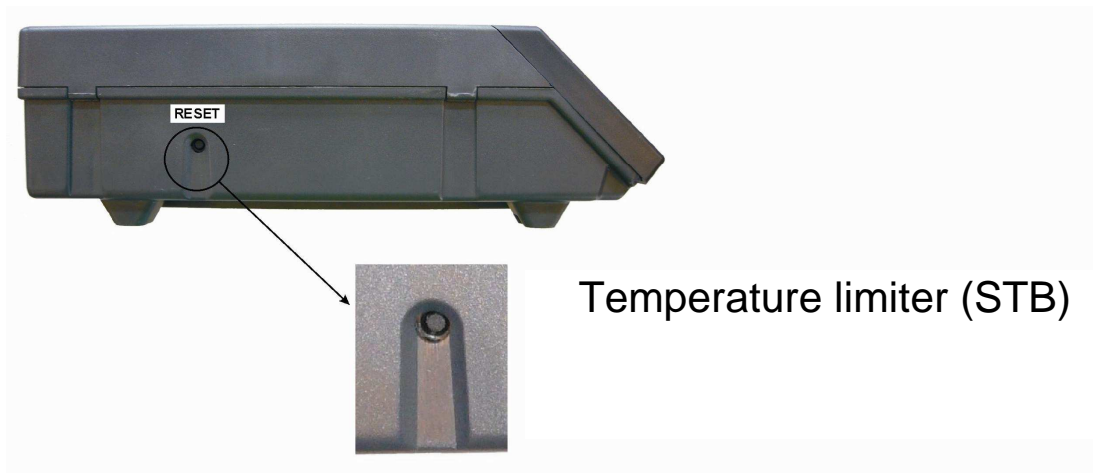

9.2. STB function restart (manual)

In order to restart the device press push-button "RESET" installed on the left side of the controller housing.



The controller does not return by itself to automatic operation due to safety reasons.

Press push-button  twice to resume the controller operation:

- first pressing of push-button  will cancel the alarm and switch off the controller
- second pressing of push-button  will restart the controller
- press push-button  - the controller will switch to automatic operation mode

CAPILLARY TUBE PUNCTURE OR BREAKAGE INDICATES THAT TEMPERATURE LIMITER FILLED WITH LIQUID LEAKS, WHICH RESULTS IN ABNORMAL OPERATION OF THE GH11NA CONTROLLER.



IN CASE IF THE ABOVE-MENTIONED DEFECT IS FOUND, IT WILL BE NECESSARY TO DISCONNECT TEMPERATURE LIMITER FROM THE GH11RNB CONTROLLER, REMOVE IT AND REPLACE WITH A NEW DEVICE.

10. PROCEDURE IN THE CASE OF CONTROLLER DAMAGE

In a case if have been noticed any irregularities in functioning of controller, user should contact with the supplier / producer or GECO company. Professional technical assistance will be given to him. If service assistance is indispensable (repair of the controller), damaged controller should be dismantled from the boiler and sent as a set (together with casing) on indicated address.



SENDING A NOT COMPLETE CONTROLLER TO THE SERVICE CAUSES AN AUTOMATIC LOSS OF THE GUARANTEE

PREPARING THE CONTROLLER TO DELIVERY TO THE SERVICE

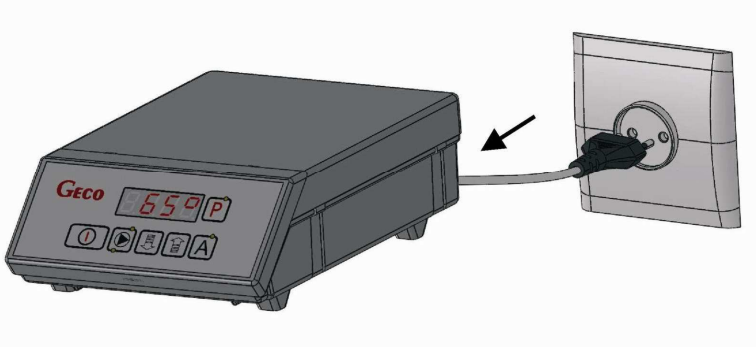
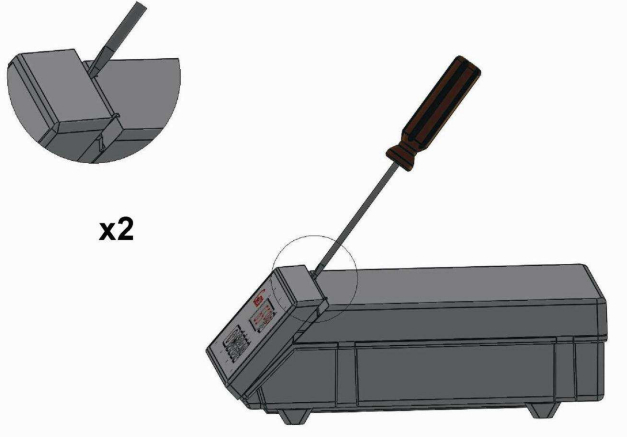
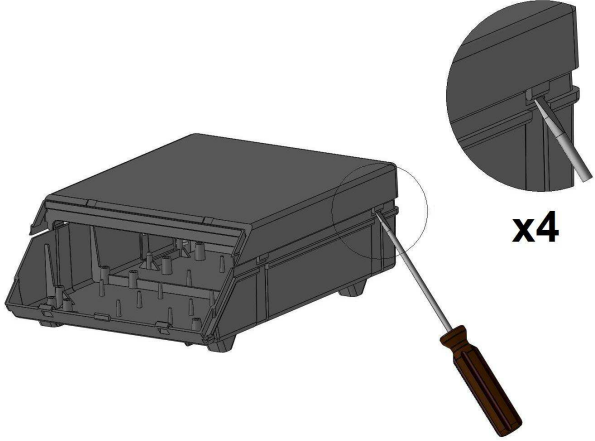
<p>STEP 1</p> <p>Disconnect a controller from power supply (remove plug from power point)</p>	
<p>STEP 2</p> <p>Remove a front panel by using of flat screwdriver</p>	
<p>STEP 3</p> <p>Remove a top part of casing (lever snap fasteners) by using of flat screwdriver</p>	

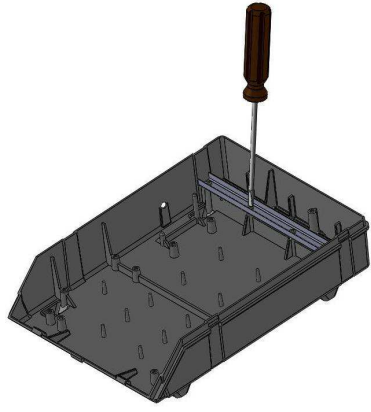
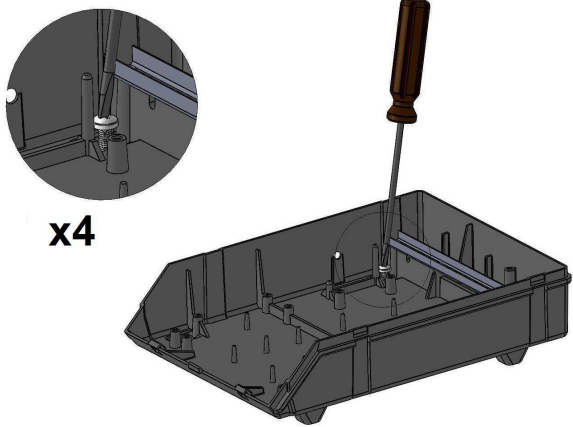
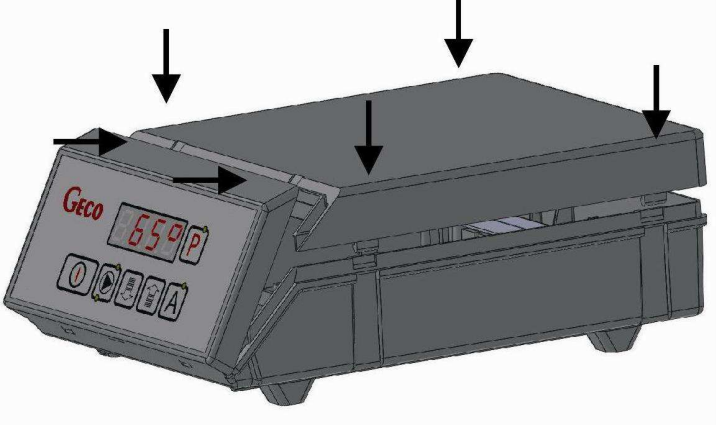
<p>STEP 4</p> <p>Remove connectors (with connected wires) from plugs, unscrew ground wires from PE strip, loosen strip which is tightening wires and take all wires out of the controller</p>	
<p>STEP 5</p> <p>Dismount a controller from boiler by unscrewing four screws in the bottom part of the casing of the controller</p>	 <p>x4</p>
<p>STEP 6</p> <p>Install top part of the casing and front panel</p>	

11. CONNECTION DEVICES TO THE GH11NA CONTROLLER

OUTPUTS			
01	L	—	Fan
02	N	—	Fan
03	L	—	---
04	N	—	---
05	L	—	Central Heating Pump C.H.
06	N	—	Central Heating Pump C.H.
07	L	—	H.U.W. Pump/ Mixing Pump
08	N	—	H.U.W. Pump/ Mixing Pump
09	N	—	Power Supply 230V
10	L	—	Power Supply 230V

INPUTS			
51, 52	—	Out water temperature sensor	
53, 54	—	H.U.W /Return temp. sensor	
55, 56	—	----	
57, 58	—	Flue gas temperature sensor	
A	—	RS-B	Room Panel GA01HA
B	—	RS-A	
C	—	GND (⊥)	
D	—	+12V AC	

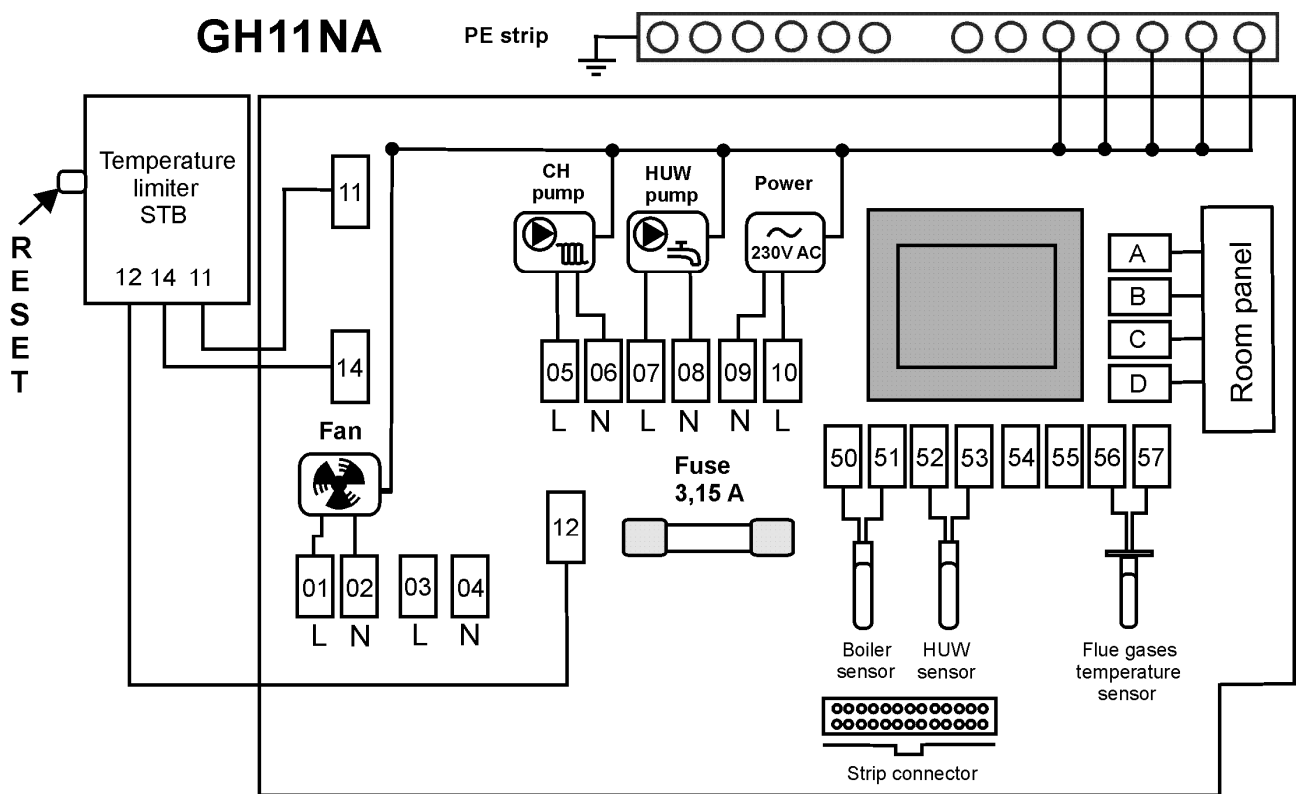

Rys. 1 Diagram of connection outputs and inputs devices and temperature sensor in the GH11NA controller.



ANY ADDITIONAL EQUIPMENT MAY BE CONNECTED TO THE GH11NA CONTROLLER ONLY BY PERSON LICENSED TO PERFORM ELECTRICAL INSTALLATION WORKS.

12. INFORMATION ON LABELLING AND COLLECTION OF WORN OUT ELECTRICAL AND ELECTRONIC EQUIPMENT

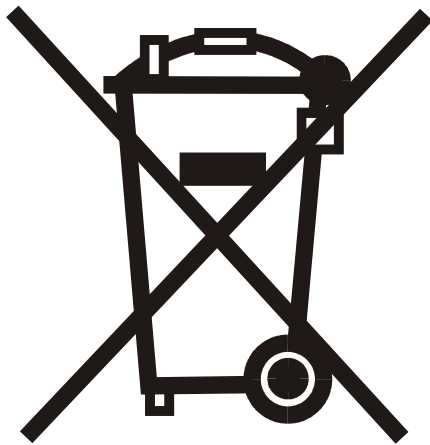

CAUTION!

This symbol placed on the product or its packaging indicates the need for selective collection of worn out electrical and electronic equipment. It means that this product should not be disposed of with other household wastes. Proper disposal of aged and worn out electrical and electronic equipment will help to avoid potentially adverse effects for environment and human health. It is the user's responsibility to collect worn out equipment separately, and to return it to an authorized disposal company.

13. NOTES

.....

.....

.....

.....

.....

.....

.....



GECO[®]

P.P.U.H. „Geco” Sp. z o. o.
Cholerzyn 376, 32-060 Liszki
tel. 012 6369811, 6361290
fax. 012 6362002
<http://www.geco.pl>
e-mail: geco@geco.pl